

DV-S525

DVD Player Instruction Manual

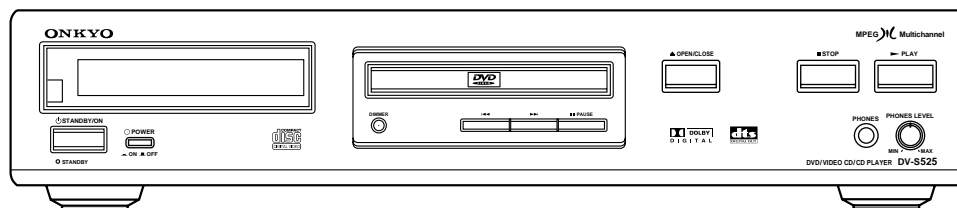

THIS DVD PLAYER IS MANUFACTURED FOR PLAYBACK OF REGION 3 (SOUTHEAST ASIA) ENCODED DVD SOFTWARE. USE OF SOFTWARE NOT INTENDED FOR REGION 3 PLAYBACK MAY RESULT IN UNDESIRABLE PLAYER PERFORMANCE.

Thank you for your purchase of the Onkyo DVD player. Please read this manual thoroughly before making connections and turning on the power. Following the instructions in this manual will enable you to obtain optimum performance and listening enjoyment from your new DVD player. Please retain this manual for future reference.

Safety Precautions

“WARNING”

“TO REDUCE THE RISK OF FIRE OR ELECTRIC SHOCK, DO NOT EXPOSE THIS APPLIANCE TO RAIN OR MOISTURE.”

CAUTION:

“TO REDUCE THE RISK OF ELECTRIC SHOCK, DO NOT REMOVE COVER (OR BACK). NO USER-SERVICEABLE PARTS INSIDE. REFER SERVICING TO QUALIFIED SERVICE PERSONNEL.”

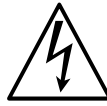

The lightning flash with arrowhead symbol, within an equilateral triangle, is intended to alert the user to the presence of uninsulated “dangerous voltage” within the product’s enclosure that may be of sufficient magnitude to constitute a risk of electric shock to persons.



The exclamation point within an equilateral triangle is intended to alert the user to the presence of important operating and maintenance (servicing) instructions in the literature accompanying the product.



Important Safeguards

1. **Read Instructions** – All the safety and operating instructions should be read before the appliance is operated.
2. **Retain Instructions** – The safety and operating instructions should be retained for future reference.
3. **Heed Warnings** – All warnings on the appliance and in the operating instructions should be adhered to.
4. **Follow Instructions** – All operating and use instructions should be followed.
5. **Water and Moisture** – The appliance should not be used near water – for example, near a bathtub, washbowl, kitchen sink, laundry tub, in a wet basement, or near a swimming pool, and the like.
6. **Carts and Stands** – The appliance should be used only with a cart or stand that is recommended by the manufacturer.
 - 6A. An appliance and cart combination should be moved with care. Quick stops, excessive force, and uneven surfaces may cause the appliance and cart combination to overturn. PORTABLE CART WARNING

S3125A
7. **Wall or Ceiling Mounting** – The appliance should be mounted to a wall or ceiling only as recommended by the manufacturer.
8. **Ventilation** – The appliance should be situated so that its location or position does not interfere with its proper ventilation. For example, the appliance should not be situated on a bed, sofa, rug, or similar surface that may block the ventilation openings; or if placed in a built-in installation, such as a book case or cabinet that may impede the flow of air through the ventilation openings, there should be free space of at least 5 cm (2 in.) and open up behind the appliance.
9. **Heat** – The appliance should be situated away from heat sources such as radiators, heat registers, stoves, or other appliances (including amplifiers) that produce heat.
10. **Power Sources** – The appliance should be connected to a power supply only of the type described in the operating instructions or as marked on the appliance.
11. **Polarization** – If the appliance is provided with a polarized plug having one blade wider than the other, please read the following information: The polarization of the plug is a safety feature. The polarized plug will only fit the outlet one way. If the plug does not fit fully into the outlet, try reversing it. If there is still trouble, the user should seek the services of a qualified electrician. Under no circumstances should the user attempt to defeat the polarization of the plug.
12. **Power- Cord Protection** – Power-supply cords should be routed so that they are not likely to be walked on or pinched by items placed upon or against them, especially wear plugs, convenience receptacles, and the point where they exit from the appliance.
13. **Cleaning** – The appliance should be cleaned only as recommended by the manufacturer.
14. **Nonuse Periods** – The power cord of the appliance should be unplugged from the outlet when left unused for a long period of time.
15. **Object and Liquid Entry** – Care should be taken so that objects do not fall and liquids are not spilled into the enclosure through openings.
16. **Damage Requiring Service** – The appliance should be serviced by qualified service personnel when:
 - A. The power-supply cord or the plug has been damaged; or
 - B. Objects have fallen, or liquid has been spilled into the appliance; or
 - C. The appliance has been exposed to rain; or
 - D. The appliance does not appear to operate normally or exhibits a marked change in performance; or
 - E. The appliance has been dropped, or the enclosure damaged.
17. **Servicing** – The user should not attempt to service the appliance beyond that described in the operating instructions. All other servicing should be referred to qualified service personnel.

Precautions

DANGER:

INVISIBLE LASER RADIATION WHEN OPEN AND INTERLOCK FAILED OR DEFEATED. AVOID DIRECT EXPOSURE TO BEAM.

CAUTION:

THIS PRODUCT UTILIZES A LASER. USE OF CONTROLS OR ADJUSTMENTS OR PERFORMANCE OF PROCEDURES OTHER THAN THOSE SPECIFIED HEREIN MAY RESULT IN HAZARDOUS RADIATION EXPOSURE.



1. This unit is a CLASS 1 LASER PRODUCT and employs a laser inside the cabinet.
2. To prevent the laser from being exposed, do not remove the cover. Refer servicing to qualified personnel.

WARNING: Changes or modifications made to this equipment, not expressly approved by Onkyo, or parties authorized by Onkyo, could void the user's warranty of the equipment.

Warranty claim

You can find the serial number on the rear panel. In case of warranty claim, please report this number.

Notes on handling

- When shipping the DVD player, the original shipping carton and packing materials come in handy. For maximum protection, repack the unit as it was originally packed at the factory.
- Do not use volatile liquids, such as insect spray, near the DVD player. Do not leave rubber or plastic products in contact with the DVD player for a long time. They will leave marks on the finish.
- The top and rear panels of the DVD player may become **warm after a long period of use. This is not a malfunction.**
- When the DVD player is not in use, be sure to remove the disc and turn off the power.
- If you do not use the DVD player for a long period, the unit may not function properly in the future. Turn on and use the DVD player occasionally.

Notes on placement

- When you place this DVD player near a TV, radio, or VCR, the playback picture may become poor and the sound may be distorted. In this case, place the DVD player away from the TV, radio, or VCR.

Notes on cleaning

Use a soft, dry cloth for cleaning.

- For stubborn dirt, soak the cloth in a weak detergent solution, wring well and wipe. Use a dry cloth to wipe it dry. Do not use any type of solvent, such as thinner and benzene, as they may damage the surface of the DVD player.
- If you use a chemical saturated cloth to clean the unit, follow that product's instructions.

To obtain a clear picture

The DVD player is a high technology, precision device. If the optical pick-up lens and disc drive parts are dirty or worn down, the picture quality becomes poor. To obtain a clear picture, we recommend regular inspection and maintenance (cleaning or parts replacement) every 1,000 hours of use depending on the operating environment. For details, contact your nearest dealer.

Notes on moisture condensation

Moisture condensation damages the DVD player. Please read the following carefully.

Moisture condensation occurs, for example, when you pour a cold drink into a glass on a warm day. Drops of water form on the outside of the glass. In the same way, moisture may condense on the optical pick-up lens inside this unit, one of the most crucial internal parts of the DVD player.

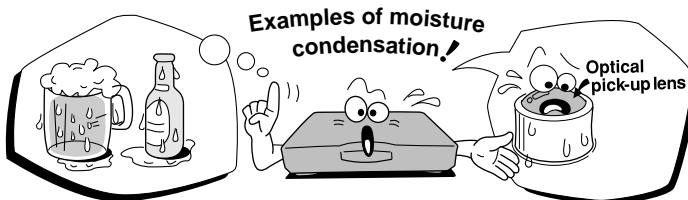

■ **Moisture condensation occurs during the following cases.**

- When you bring the DVD player directly from a cold place to a warm place.
- When you use the DVD player in a room where you just turned on the heater, or a place where the cold wind from the air conditioner directly hits the unit.
- In summer, when you use the DVD player in a hot and humid place just after you move the unit from an air conditioned room.
- When you use the DVD player in a humid place.

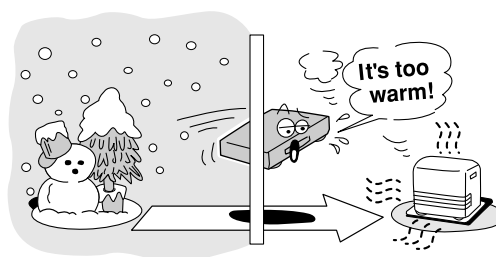

■ **Do not use the DVD player when moisture condensation may occur.**

If you use the DVD player in such a situation, it may damage discs and internal parts. Remove the disc, connect the power cord of the DVD player to the wall outlet, turn on the DVD player, and leave it for two or three hours. After two or three hours, the DVD player will have warmed up and evaporated any moisture. Keep the DVD player connected to the wall outlet and moisture condensation will seldom occur.

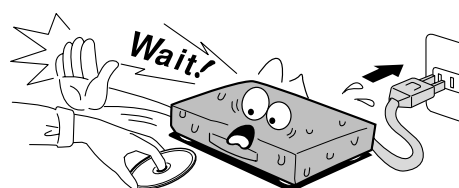

Features

- **Audiophile-class DVD/VIDEO CD/CD player**
- **Component Video Outputs**
- **Dolby* Digital Audio Output**
- **10-Bit Video D/A conversion**
- **Optical & Coaxial digital audio output**
- **4-power picture zoom**
- **Brushed aluminum front panel**
- **DTS** Bitstream Digital Out**
- **MPEG-2 Play back**

* Manufactured under license from Dolby Laboratories. "Dolby" and the double-D symbol are trademarks of Dolby Laboratories. Confidential Unpublished Works. ©1992-1997 Dolby Laboratories, Inc. All rights reserved.

** "DTS" and "DTS Digital Surround" are trademarks of Digital Theater Systems, Inc.

Table of Contents

Introduction

- Safety Precautions 2
- Important Safeguards 2
- Precautions 3-5
- Features 6
- Identification of Controls 8-11
 - Front panel/rear panel/DVD display
 - Remote controller
 - Preparing the remote controller
 - Operating with the remote controller

Introduction

Connections

- Connecting to a TV 12
- Connecting to an Audio System and TV with COMPONENT VIDEO Inputs 13
- Connecting to Optional Equipment ... 14, 15
 - Connecting to an amplifier equipped with a Dolby Digital decoder
 - Connecting to an amplifier equipped with a Dolby Pro Logic Surround
 - Connecting to an amplifier equipped with a DTS decoder
 - Connecting to an amplifier equipped with a digital audio input
 - Connecting to an amplifier equipped with an MPEG 2 audio decoder

Connections

Basic Playback

- Playing a Disc 16-19
 - Basic playback
 - Playing fast in reverse or forward
 - Playing frame by frame
 - Playing in slow-motion
 - Resuming playback from the same location
- Locating a Specific Title, Chapter, or Track 20, 21
 - Locating a title using the title menu
 - Locating a title by entering the title
 - Locating a specific chapter or track directly
 - Locating a specific chapter or track

Basic playback

Advanced Playback

- Playing From the Desired Location 22
 - Entering the time of the desired location
- Playing Repeatedly 23
 - Repeating a title, chapter, or track
 - Repeating a specific segment
- Playing in a Favorite Order 24
 - Setting Titles, Chapters, or Tracks in a Favorite Order
- Playing in Random Order 25
 - Playing titles in random order
 - Playing chapters or tracks in random order
- Zooming a Picture 26
 - Zooming a picture
- Selecting the Camera Angle 27
 - Changing the camera angle
- Selecting a Language 28
 - Selecting a playback audio setting
- Selecting Subtitles 29
 - Selecting a subtitle language
 - To turn subtitles on or off
- Viewing the Operational Information 30
 - Checking the operational status
 - Checking the remaining time and setting status

Advanced playback

Function Setup

- Customizing the Function Settings 31-39
 - Selecting procedure
 - Setting details
- Table of Languages 40
 - Table of languages and their abbreviations

Function setup

Others

- Notes on Discs 41
 - On handling discs
 - On cleaning discs
 - On storing discs
 - About this instruction manual
 - Notes on region numbers
 - Playable discs
- On VIDEO CDs
 - Notes on copyright
- Before Calling Service Personnel 42
 - Symptoms and Correction
- Specifications 43

Others

Identification of Controls

See the page in  for details.

Front panel/rear panel/DVD display

■ Front panel

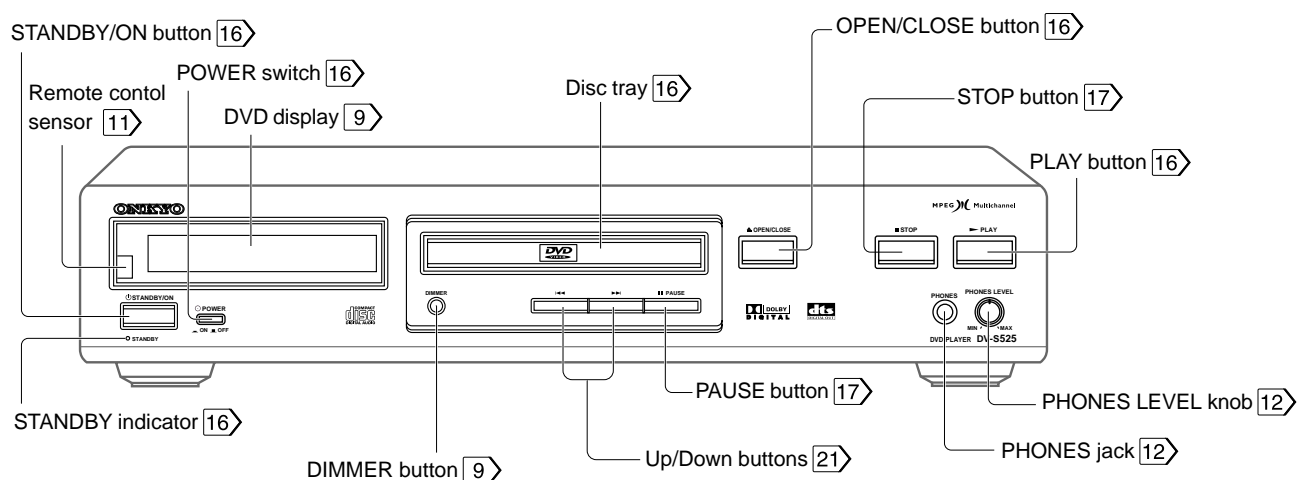

■ Rear panel

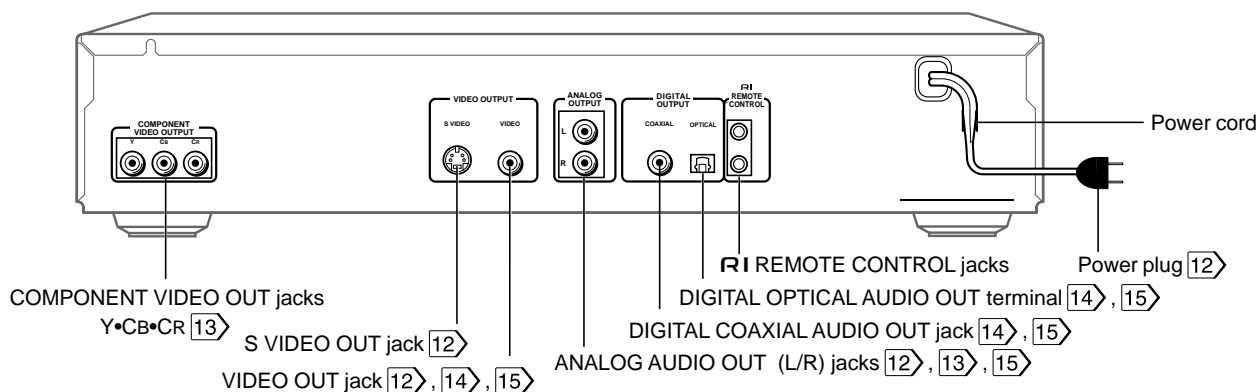

Connections for remote control (RI)

When connecting ONKYO products, it is necessary to attach the **RI** cable to be able to use the remote controller of the main component to control the entire system.

1. To use this DVD player with an amplifier (or receiver), cassette tape deck and tuner with the **RI** symbol, insert the remote control cable plugs into the REMOTE CONTROL jacks.
2. As the exact connection sequence of the **RI** cable is unimportant, you can connect from the amplifier (or receiver) to either the tuner, the cassette tape deck or to the compact disc player.
3. If using an **RI** equipped ONKYO amplifier (or receiver), to operate correctly, the remote controller must face towards the remote control sensor of the amplifier (or receiver).

Notes:

- The upper and lower **RI** remote control jacks have the same function.
- Remote control operation is not possible when only the remote control cable is connected — the audio connection cables must also be connected.
- An **RI** remote control cable equipped with a 1/8" (3.5mm) diameter miniature two-conductor phone plug is included with this unit and with every tuner, compact disc player or cassette tape deck with the **RI** symbol.

■ DVD display

- Pressing of the DIMMER button changes the brightness of the Display.

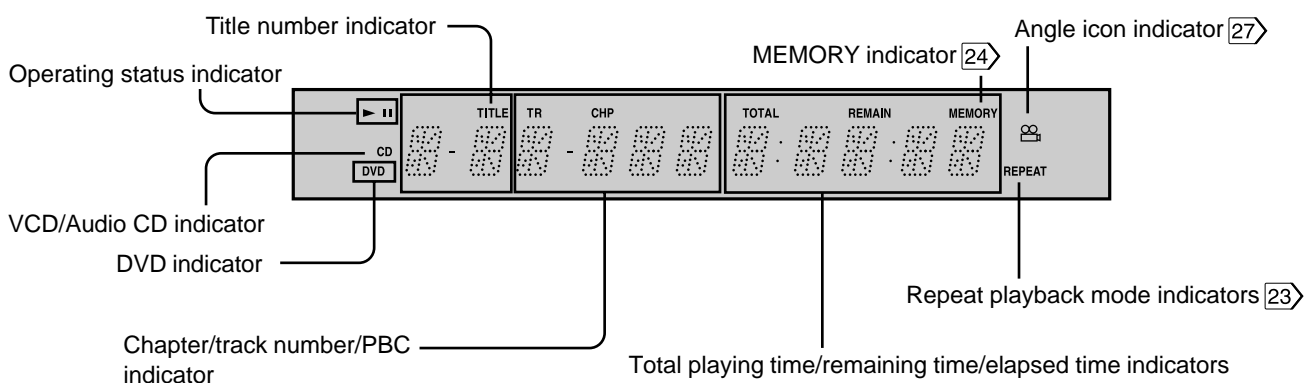

■ The indicators vary depending on the kinds of discs you play.

■ DVD video

- When closing the disc tray:
Example



Total number of titles

- During playback:

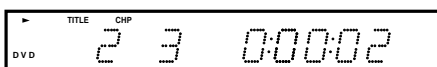

Playing chapter 3 in title 2

Elapsed time of the current title

Some DVD video may not display the chapter numbers or elapsed time.

■ VIDEO CD

- When closing the disc tray:
Example

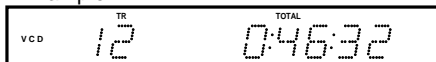

Total number of tracks

Total playing time of the disc

- During playback:

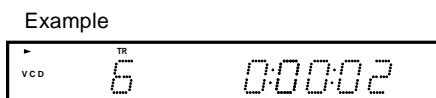

Playing track 6

Elapsed time of the current title

Some VIDEO CDs may not display the track numbers or elapsed time.

■ Audio CD

- When closing the disc tray:
Example

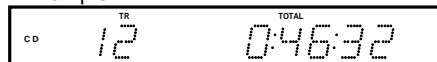

Total number of tracks

Total playing time of the disc

- During playback:

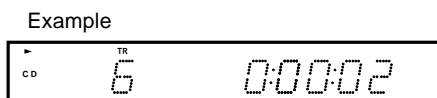

Playing track 6

Elapsed time of the current title

Identification of Controls (continued)

The instructions in this manual describe the controls on the remote controller. See the page in  for details.

Remote controller

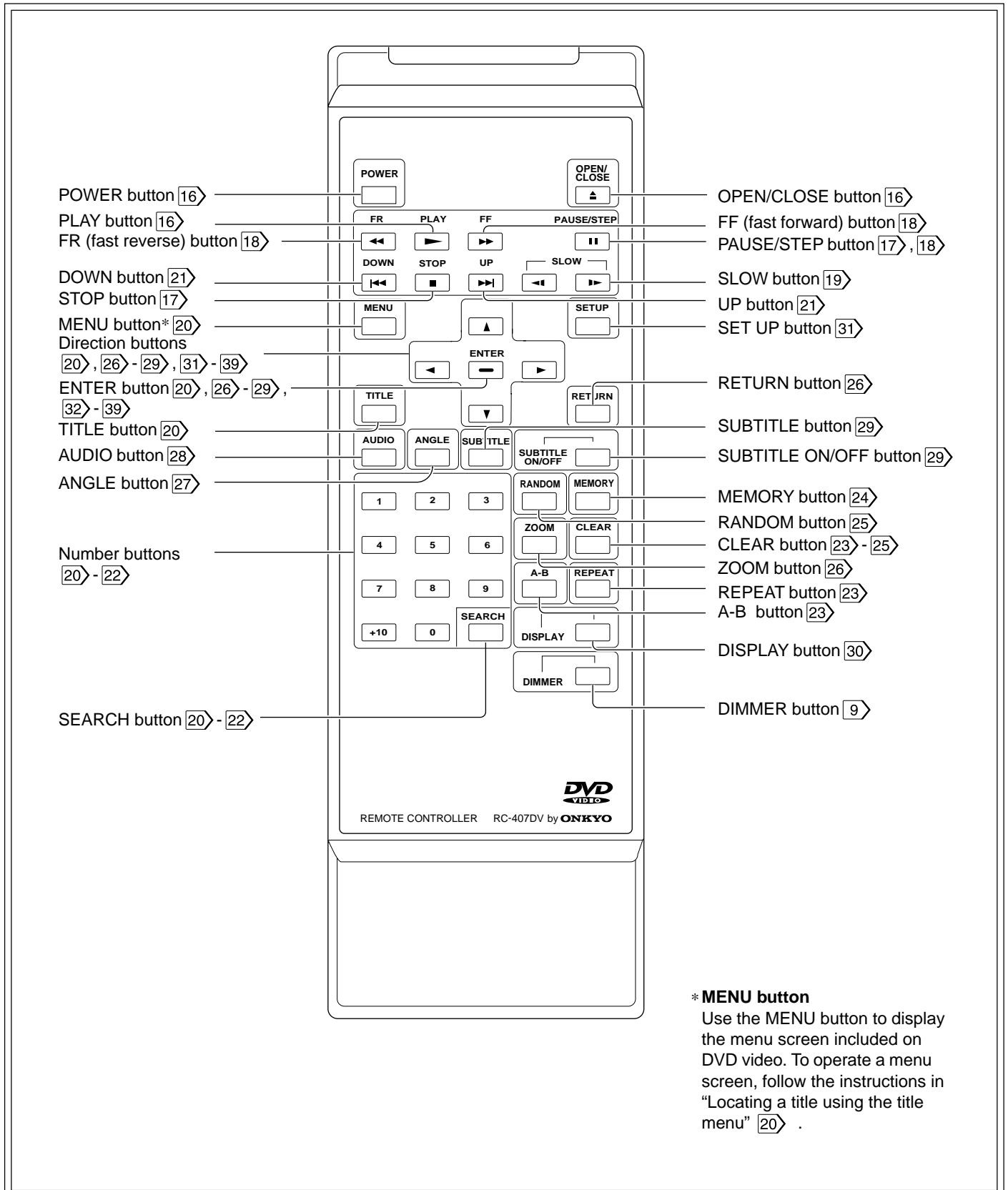

*** MENU button**

Use the MENU button to display the menu screen included on DVD video. To operate a menu screen, follow the instructions in "Locating a title using the title menu" [20](#) .

Preparing the remote controller

Insert the batteries into the remote controller so you can use it to operate the DVD player.

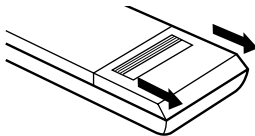
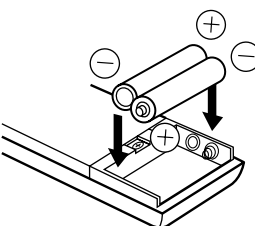
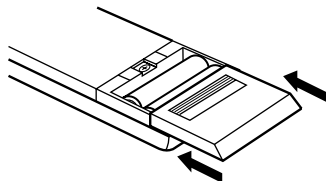
1	<p>Open the cover.</p> 
2	<p>Insert batteries (AA size).</p>  <p>Make sure to match the + and – on the batteries to the marks inside the battery compartment.</p>
3	<p>Close the cover.</p> 

Notes on batteries:

Improper use of batteries may cause battery leakage and corrosion. To operate the remote controller correctly, follow the instructions below.

- Do not insert the batteries into the remote controller in the wrong direction.
- Do not charge, heat, open, or short-circuit the batteries. Do not throw the batteries into a fire.
- Do not leave dead or exhausted batteries in the remote controller.
- Do not use different types of batteries together, or mix old and new batteries.
- If you do not use the remote controller for a long period of time, remove the batteries to avoid possible damage from battery corrosion.
- If the remote controller does not function correctly or if the operating range becomes reduced, replace all batteries with new ones.
- If battery leakage occurs, wipe the battery liquid from the battery compartment, then insert new batteries.
- The batteries should last about one year under normal usage.

Operating with the remote controller

This section shows you how to use the remote controller.

Point the remote controller at the remote sensor and press the buttons.

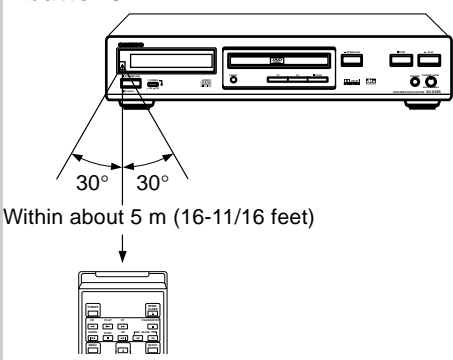

Distance: About 5 m (16-11/16 feet) from the front of the remote sensor
 Angle: About 30° in each direction of the front of the remote sensor

* Do not expose the remote sensor of the DVD player to a strong light source such as direct sunlight or illumination. If you do so, you may not be able to operate the DVD player with the remote controller.

Notes on the remote controller:

- Direct the remote controller at the remote sensor of the DVD player.
- Do not drop or give the remote controller a shock.
- Do not leave the remote controller near an extremely hot or humid place.
- Do not spill water or put anything wet on the remote controller.
- Do not open the remote controller.

Connecting to a TV

For details of Output sound, see [28](#).

Connect the DVD player to your TV.

Connecting to a TV

■ Setting of the output sound type

From the on-screen displays, set the "Audio Out Select" to "Analog 2ch". [36](#)

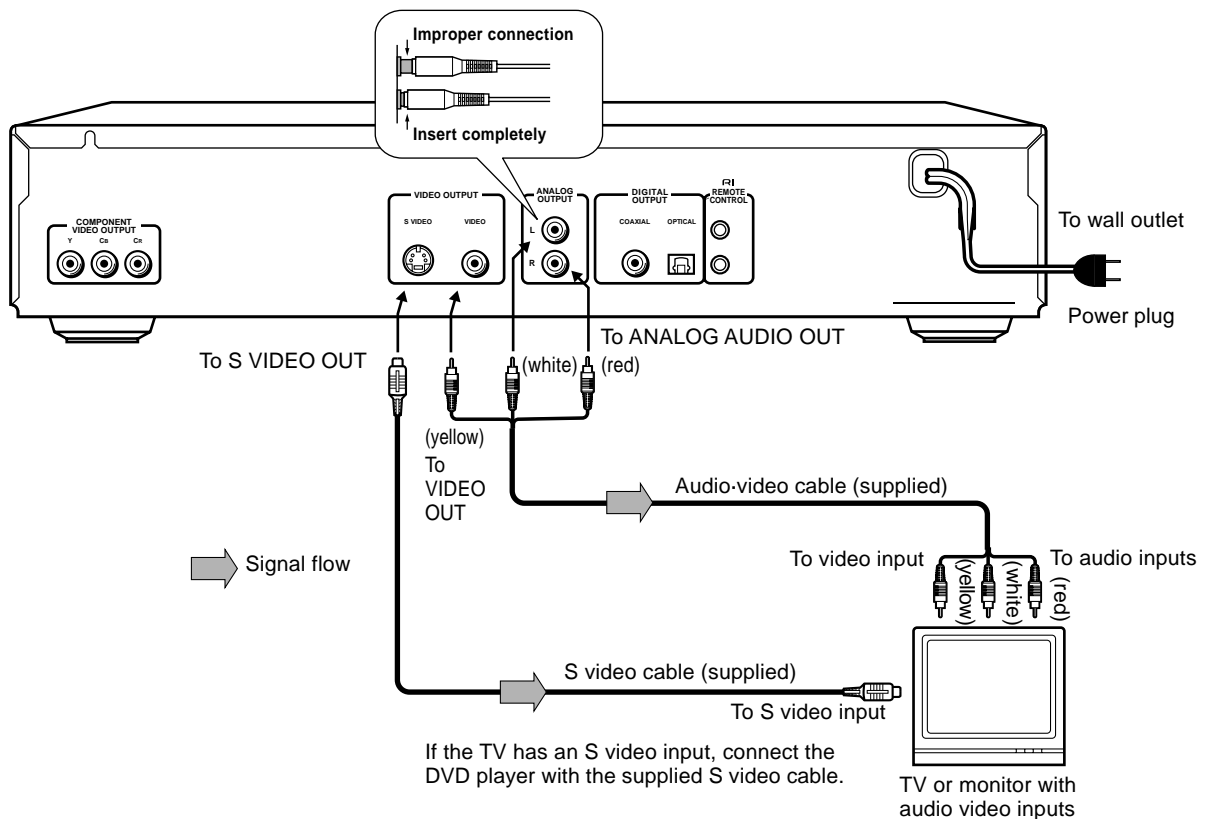

Notes:

- Refer to the instruction manual of the connected TV and how to activate TV input as well.
- When you connect the DVD player to your TV, be sure to turn off the power and unplug both units from the wall outlet before making any connections.
- If your television set has one audio input, connect the DVD player to a Y cable adapter (not supplied) and then connect to your TV.
- Connect the DVD player to your TV directly. If you connect the DVD player to a VCR, TV/VCR combination or video selector, the playback picture may be distorted as DVD discs are copy protected.

Connecting headphones

Connect headphones to the PHONES jack on the front panel using a stereo plug.

Before connecting, temporarily turn down the volume with the PHONES LEVEL volume. Readjust to your preference when playback begins.

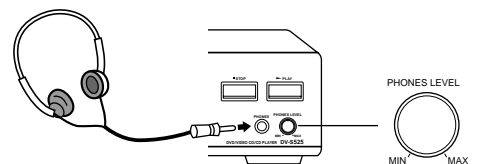

Connecting to an Audio System or TV with COMPONENT VIDEO Inputs

For details of Output sound, see 28.

You can listen to the sound of audio CDs and DVD video in stereo and enjoy the enhanced picture quality of DVD video on a TV with COMPONENT VIDEO inputs.

Connecting to an audio system and TV with COMPONENT VIDEO inputs

■ Setting of the output sound type

From the on-screen displays, set the "Audio Out Select" to "Analog 2ch". 36

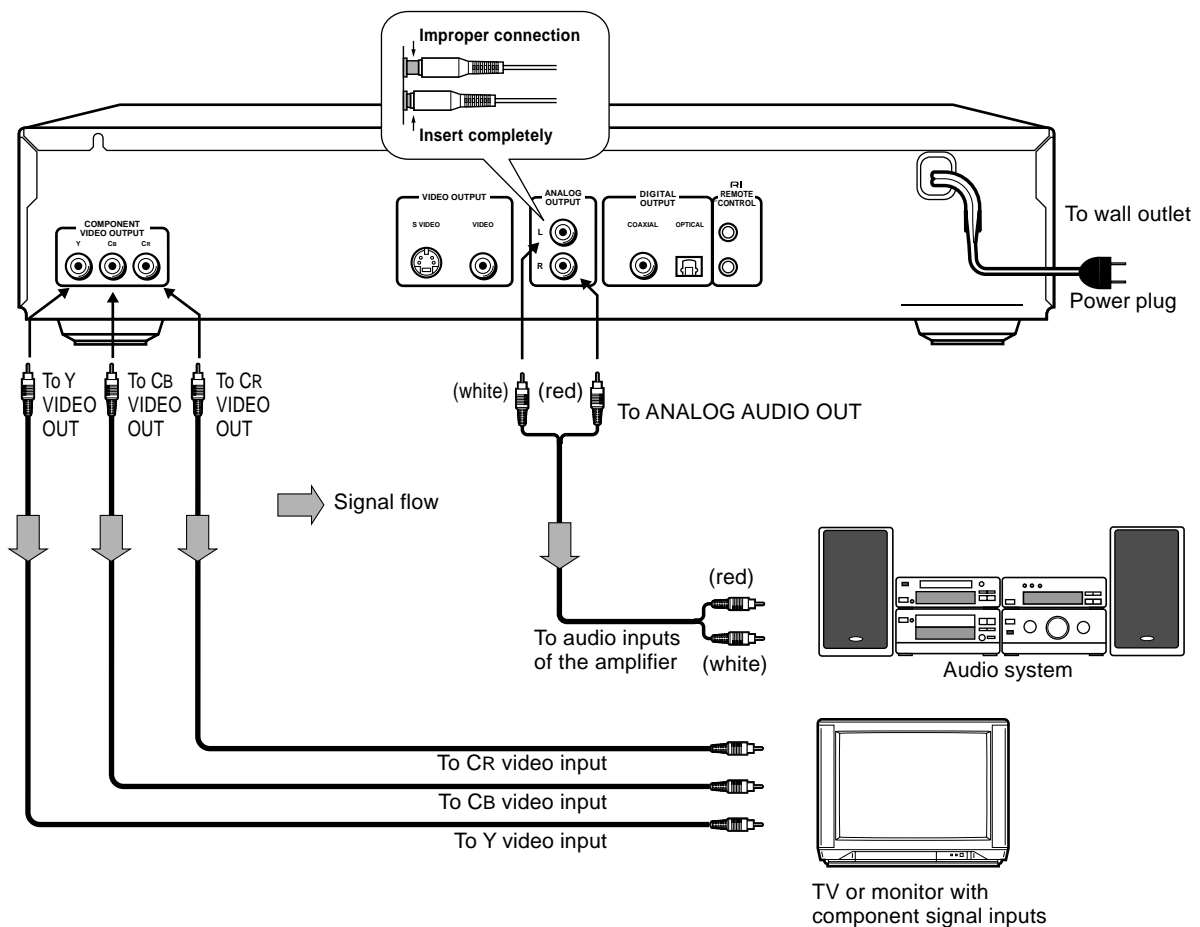

COMPONENT VIDEO OUT (COLOR DIFFERENCE):

Some TVs or monitors are equipped with color difference inputs. Connecting to these inputs allows you to enjoy higher quality picture playback.

Actual labels for color difference inputs may vary depending on the TV manufacturer. (ex. Y, B-Y, R-Y etc.)

In some TVs or monitors, the color levels of the playback picture may be reduced slightly or the tint may change. In such a case, adjust the TV or monitor for optimum performance.

Notes:

- Refer to the instruction manual of the connected equipment as well.
- When you connect the DVD player to other equipment, be sure to turn off the power and unplug all of the equipment from the wall outlet before making any connections.
- If you place the DVD player near a tuner or radio, the radio broadcast sound might be distorted. In this case, place the DVD player away from the tuner and radio.
- The output sound of the DVD player has a wide dynamic range. Be sure to adjust the receiver's volume to a moderate listening level. Otherwise, the speakers may be damaged by a sudden high volume sound.
- Turn off the amplifier before you connect or disconnect the DVD player's power cord. If you leave the amplifier power on, the speakers may be damaged.

Connecting to Optional Equipment

You can enjoy high quality dynamic sounds by connecting the DVD player to optional audio equipment. For connection to your TV, see pages 12 and 13. Select the connection type depending on your audio equipment.

Notes:

- DO NOT connect the DIGITAL OUTPUT jack of the DVD player to the AC-3 RF input of a Dolby Digital Receiver. This input on you're A/V Receiver is reserved for Laserdisc use only and is incompatible with the DIGITAL OUTPUT jack of the DVD player.
- Connect the DIGITAL OUTPUT jack of the DVD player to the "DIGITAL" or "COAXIAL" input of a Receiver or Processor.
- Refer to the Instruction manual of the connected equipment as well.
- When you connect the DVD player to other equipment, be sure to turn off the power and unplug all of the equipment from the wall outlet before making any connections.
- The output sound of the DVD player has a wide dynamic range. Be sure to adjust the receiver's volume to a moderate listening level. Otherwise, the speakers may be damaged by a sudden high volume sound.
- Turn off the amplifier before you connect or disconnect the DVD player's power cord. If you leave the amplifier power on, the speakers may be damaged.

Connecting to an amplifier equipped with a Dolby Digital decoder

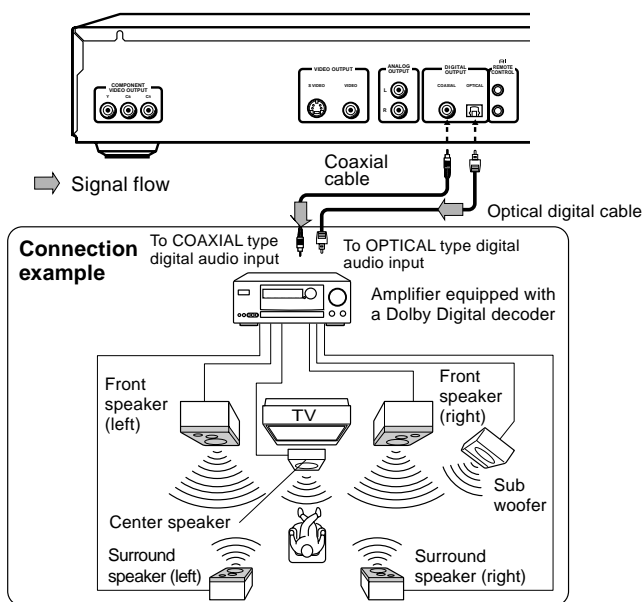

Dolby Digital

Dolby Digital is the surround sound technology used in theaters showing the latest movies, and is now available to reproduce this realistic effect in the home. You can enjoy motion picture and live concert DVD video with this dynamic realistic sound by connecting the DVD player to a 6 channel amplifier equipped with a Dolby Digital decoder or Dolby Digital processor. If you have a Dolby Pro Logic Surround decoder, you will obtain the full benefit of Pro Logic from the same DVD movies that provide full 5.1-channel Dolby Digital soundtracks, as well as from titles with the Dolby Surround mark.

- Use DVD video encoded via the Dolby Digital recording system.
- Make the following setting

Setting	Select:	Page
Audio Out Select	Bitstream	31, 36
Recording system	□□	28

Connecting to an amplifier equipped with a Dolby Pro Logic Surround

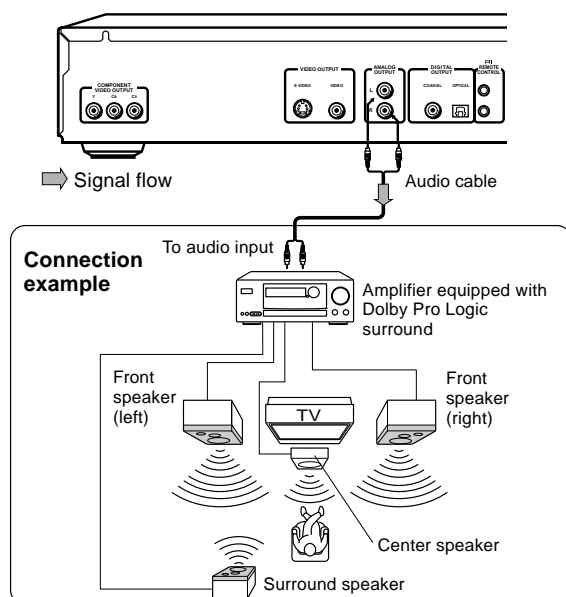

Connect one or two surround speakers. The output sound from the surround speakers will be monaural even if you connect two surround speakers.

Dolby Pro Logic Surround

You can enjoy the dynamic realistic sound of Dolby Pro Logic Surround by connecting an amplifier and speaker system (right and left front speakers, a center speaker, and one or two rear speakers).

- **With an amplifier equipped with Dolby Digital**
Connect the equipment the same way as described in "Connecting to an Amplifier equipped with a Dolby Digital Decoder." Refer to that amplifier's owner's manual and set the amplifier so you can enjoy Dolby Pro Logic Surround sound.
- **With an amplifier not equipped with Dolby Digital**
Connect the equipment as follows.
- Make the following setting

Setting	Select:	Page
Audio Out Select	Analog 2ch	31, 36

Note:

- Be sure to set "Audio Out Select" to "Analog 2ch" when you enjoy sounds of Dolby Pro Logic Surround using this connection.

Warning

- Do not set "Audio Out Select to "Bitstream" from the menu [31](#) , [36](#) unless you are connecting (via the DIGITAL OUTPUT jack) an AV decoder that has the Dolby Digital or Digital Theater System (DTS) decoding function. High volume sound may damage your hearing as well as the speakers.
- When playing DTS-encoded discs (DVD video and audio CDs), excessive noise may be exhibited from the analog stereo jacks. To avoid possible damage to the audio system, you should take proper precautions when the ANALOG OUTPUT jacks of the DVD player is connected to an amplification system. To enjoy DTS Digital Surround™ playback, an external 5.1 channel DTS Digital Surround™ decoder system must be connected to the DIGITAL OUTPUT jack of the DVD player.

Connecting to an amplifier equipped with a DTS decoder

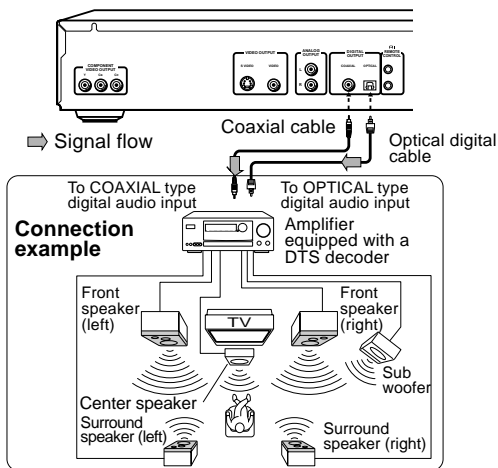

Digital Theater Systems (DTS)

DTS is a high quality surround technology used in theaters and now available for home use, on DVD video or audio CDs. If you have a DTS decoder or processor, you can obtain the full benefit or 5.1 channel DTS encoded sound tracks on DVD video or audio CDs.

- Use DVD video or audio CDs encoded via the DTS recording system.
- Make the following setting

Setting	Select:	Page
Audio Out Select	Bitstream	31 , 36
Recording system	DTS	28

Connecting to an amplifier equipped with a digital audio input

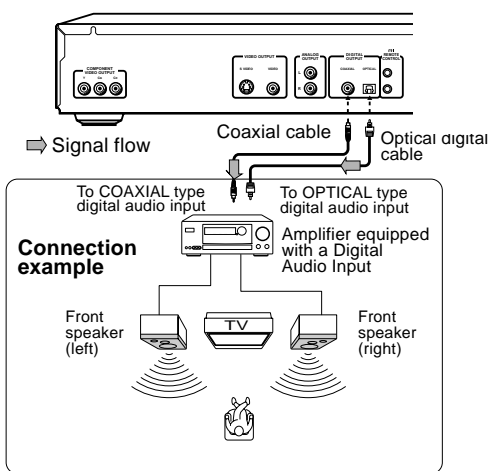

2 Channel Digital Stereo

You can enjoy the dynamic sound of 2 Channel Digital Stereo by connecting an amplifier equipped with a digital audio input and speaker system (right and left front speakers).

- Make the following setting

Setting	Select:	Page
Audio Out Select	PCM	31 , 36

Connecting to an amplifier equipped with an MPEG 2 audio decoder

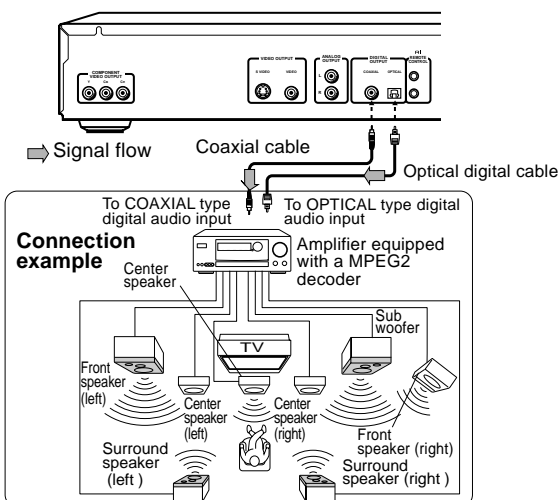

MPEG 2 sound

You can enjoy motion picture and live concert DVD video with dynamic realistic sound by connecting a 6 or 8 channel amplifier equipped with MPEG 2 audio decoder or MPEG 2 audio processor.

- Make the following setting

Setting	Select:	Page
Audio Out Select	Bitstream	40
Recording system	MPEG	29

Playing a Disc

CAUTION

Keep your fingers well clear of the disc tray as it is closing. Neglecting to may cause serious personal injury.

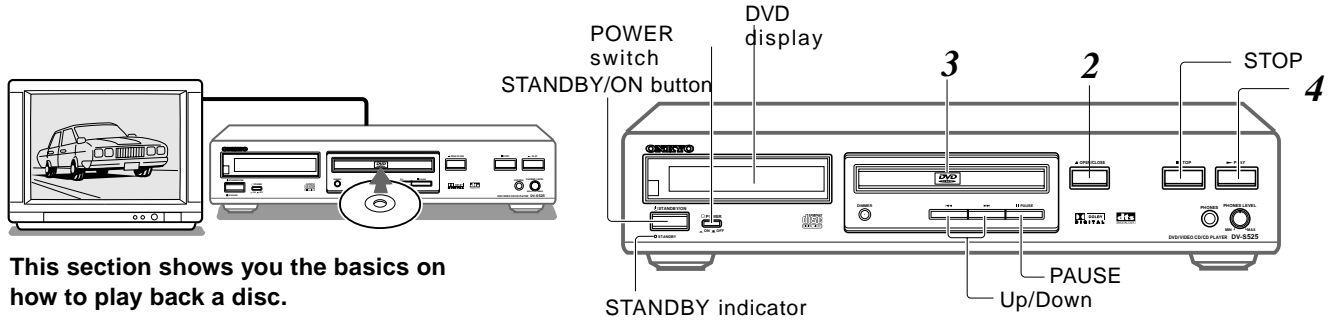

This section shows you the basics on how to play back a disc.

Basic playback

■ Preparations

- When you want to view a disc, turn on the TV and select the video input connected to the DVD player.
- When you want to enjoy the sound of discs from the audio system, turn on the audio system and select the input connected to the DVD player.
- For connection details, see "Connections". [12](#) - [15](#)

<p>1</p> <p>POWER ON</p> <p>STANDBY</p>	<h3>Connecting the power supply.</h3> <ol style="list-style-type: none"> 1. Plug the power cord into an AC wall outlet. 2. Press the POWER switch. The STANDBY indicator on the player illuminates. 3. Press the STANDBY/ON button or POWER button on the remote controller to turn on the DVD player. The display lights up and the STANDBY indicator goes off. 	<p>Note:</p> <p>You cannot use the remote controller if the POWER button on the DVD player is set to OFF.</p>
<p>2</p> <p>OPEN/CLOSE</p>	<h3>Press OPEN/CLOSE.</h3> <p>The disc tray opens. It may take a few seconds before the system power actually turns ON. If the tray does not open, press the OPEN/CLOSE button again.</p>	<p>Note:</p> <p>You can open the disc tray by pressing this button even if the DVD player is turned off.</p>
<p>3</p>	<h3>Place the disc on the disc tray.</h3> <p>With the playback side down</p>	<p>Notes:</p> <ul style="list-style-type: none"> • There are two different disc sizes. Place the disc in the correct guide on the disc tray. If the disc is out of the guide, it may damage the disc and cause the DVD player to malfunction. • Do not place anything except DVD videos, VIDEO CDs or audio CDs on the disc tray.
<p>4</p> <p>PLAY</p>	<h3>Press PLAY.</h3> <p>The disc tray closes and playback starts.</p> <p>If you insert a DVD video that contains a title menu, or insert a PBC (Playback Control)-equipped VIDEO CD, a menu screen may appear. See "Locating a title using the title menu" 20. To start playback of a PBC-equipped VIDEO CD from the menu screen, set "PBC" to "ON" via the on-screen displays. 31 39</p>	<p>Note:</p> <ul style="list-style-type: none"> • For PBC (Playback Control) of VIDEO CDs, see "On VIDEO CD" 41. • You may need to press the TITLE or MENU button to display the menu screen depending on the DVD videos. <p>Tip: If the disc has already been set in the tray, pressing the PLAY button starts playback while the system is in STANDBY status.</p>

■ First Setup screen

The First Setup screen appears only once when the DVD player is turned on for the first time. From this screen, make the following settings.

On-screen Language: Select the appropriate on-screen language.

TV Shape: Select a picture size according to the aspect ratio of your TV (See [35](#) for details.)

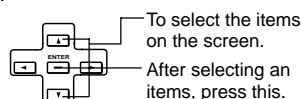
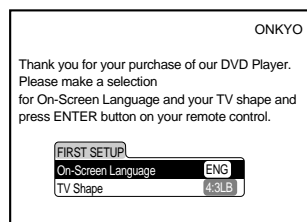

1. Press the ▲/▼ buttons to select "On-Screen Language," and press the ENTER button.
2. Select a language using the ▲/▼ buttons, and press the ENTER button.
3. Press the ▼ button to select "TV Shape," and press the ENTER button.
4. Select a picture size (see [35](#)) using the ▲/▼ buttons, and press the ENTER button.
5. Finally press the SETUP button.
All your selections are entered and the First Setup screen disappears.

To change your settings, see "Customizing the Function Settings." [31](#)

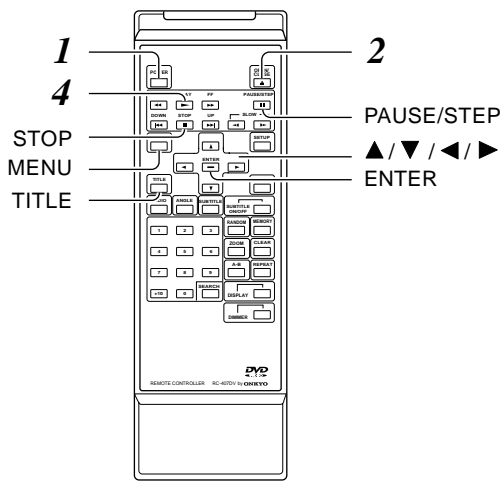

■ **To obtain a higher quality picture**

Occasionally, some picture noise not usually visible during a normal broadcast may appear on the TV screen while playing a DVD video because the high resolution pictures on these discs include a lot of information. While the amount of noise depends on the TV you use with this DVD player, you should generally reduce the sharpness adjustment on your TV when viewing DVD videos.

■ **About DVD VCD CD**

The DVD VCD CD icons on the heading bar show the playable discs for the function described under that heading.

DVD : You can use this function with DVD videos

VCD : You can use this function with VIDEO CDs

CD : You can use this function with audio CDs



■ **To pause playback (still mode)**

PAUSE/STEP

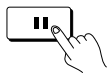

Press PAUSE/STEP during playback.

To resume normal playback, press the PLAY button.

- The sound is muted during still mode.

■ **To stop playback**

STOP

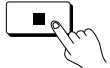

Press STOP.

■ **To remove the disc**

OPEN/CLOSE

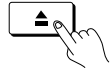

Press OPEN/CLOSE.

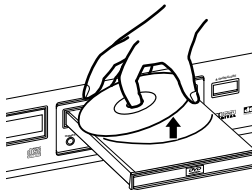

Remove the disc after the disc tray opens completely.

- Be sure to press the OPEN/CLOSE button to close the disc tray after you remove the disc.

■ **About the screen saver**

If you pause a picture of a DVD video and leave it still for a long while, the screen saver of the DVD player automatically appears (when "Screen Saver" is set to "On" [37]). To turn off the screen saver, press the PLAY button.

Notes:

- Do not move the DVD player during playback. Doing so may damage the disc.
- Use the OPEN/CLOSE button on the remote controller or DVD player to open and close the disc tray. Do not push the disc tray while it is moving. Doing so may cause the DVD player to malfunction.
- Do not push up on the disc tray or put any objects other than discs on the disc tray. Doing so may cause the DVD player to malfunction.
- In many instances, a menu screen will appear after playback of a movie is completed. Prolonged display of an on-screen menu may damage your television set, permanently etching that image onto its screen. To avoid this, be sure to press the STOP button on your remote controller once the movie is completed.

Playing a Disc (continued)

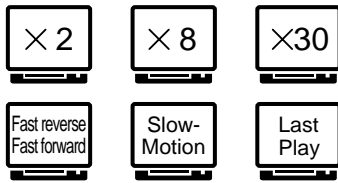

You can play discs at various speeds, and resume playback from the location where you stopped playback.

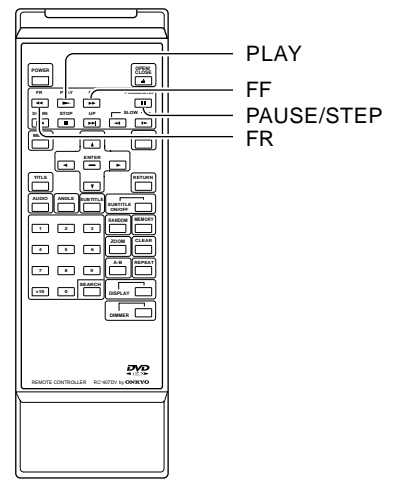

Playing fast in reverse or forward

Press FR or FF during playback.

• DVD video

The playback speed becomes x2 the normal speed.
Each time you press the FR or FF button, the playback speed changes.

FR: Fast reverse playback
FF: Fast forward playback

TV screen

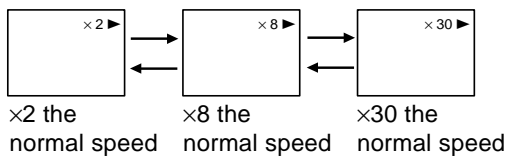

• VIDEO CD/Audio CD

The fast reverse or fast forward playback alternates between two speeds.

TV screen

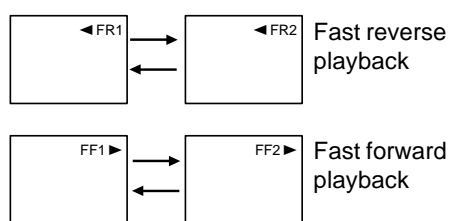

■ To resume normal playback

PLAY



Press PLAY.

Notes:

- The DVD player does not play back sound and subtitles during scan reverse and forward of DVD videos. However, the DVD player plays back sound during fast forward or fast reverse playback of audio CDs.
- The playback speed may differ depending on the disc.

Playing frame by frame

PAUSE/STEP



Press PAUSE/STEP during still playback.

Each time you press the PAUSE/STEP button, the picture advances one frame.

■ To resume normal playback

PLAY

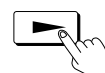

Press PLAY.

Note:

The sound is muted during frame by frame playback.

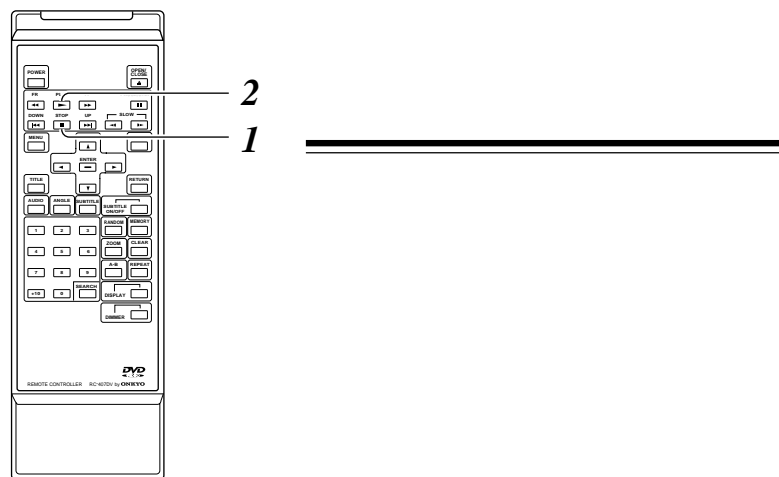
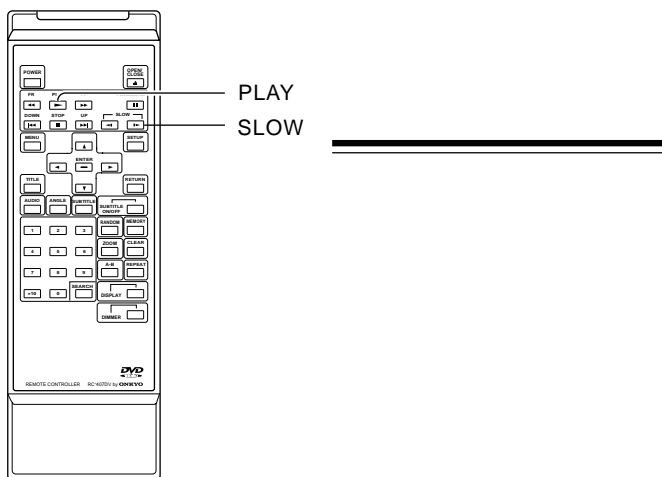

DVD VCD
Playing in slow-motion

DVD VCD CD
Resuming playback from the same location

Press SLOW during playback.
 Each time you press the SLOW button, the slow-motion speed changes.

TV screen

1/2 the normal speed 1/4 the normal speed 1/8 the normal speed

If you press the SLOW button during playback, you can view the picture in reverse slow-motion (only when using a DVD video.)
 Each time you press the SLOW button, the slow-motion speed changes.

1 Press STOP at the location where you want to interrupt playback.

- The DVD player memorizes the location where playback is stopped.

2 Press PLAY.
 The DVD player resumes playback from the location where you stopped playback.

To resume normal playback

Press PLAY.

To start playback from the beginning regardless of the location where you stopped playback.

1. Press STOP twice.

The DVD video's memory is cleared.

2. Press PLAY.

If you are using a DVD video, playback starts from the beginning of the current title.
 If you are using a VIDEO CD/audio CD, playback starts from the beginning of the disc.

- If you want to return to the beginning of a DVD video, open and close the disc tray once with the OPEN/CLOSE button before pressing the PLAY button.

Note:
 The sound is muted during slow-motion playback.

- Notes:**
- The DVD player's memory is also cleared when:
 - you unplug the DVD player from the wall outlet after you stop playback.
 - you open the disc tray.
 - you change parental lock setting [38] or select a disc menu language setting [33].
 - There may be a difference of the location where playback resumes depending on the disc.
 - Settings you changed using the on-screen displays while the DVD player keeps a location in the memory may function only after the memory is cleared.

Locating a Specific Title, Chapter, or Track

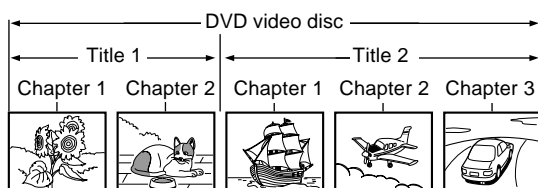

Normally, DVD videos are divided into titles, and the titles are sub-divided into chapters. VIDEO CDs and audio CDs are divided into tracks. You can quickly locate any specific title, chapter, or track.

Locating a title using the title menu DVD

- 1** **TITLE**

Press TITLE.
The title menu appears on the TV screen.
Example of a title menu
- 2**

Press ▲/▼/◀/▶ to select the title you want.
If the titles in the title menu are assigned a number, you can directly locate a specific title by pressing its assigned number with the **number buttons**.
- 3** **ENTER**

Press ENTER.
Playback starts from chapter 1 of the selected title.

Notes:

- The instructions above describe basic procedures which may vary depending on the contents of the DVD video. If different instructions appear on the TV screen, follow those instructions.
- If you display the title menu during playback and press the TITLE button again without selecting any title, the DVD player resumes playback from the point where you first pressed the TITLE button. (depending on the actual DVD video)
- This method of locating a title is available only on a disc that contains a title menu.
- Instruction notes of discs may refer to the button that displays the title menu as TOP MENU button.

Locating a title by entering the title DVD

- 1** **SEARCH**

Press SEARCH.
Make sure that the space next to Title is highlighted. (You can shift the highlight using the ▲/▼ buttons.)
e.g.
- 2**

Press the corresponding number buttons for the title you want.
e.g. To select title 2

To select title 12
- 3** **PLAY**

Press PLAY.
Playback starts from chapter 1 of the selected title.

Notes:

- This method of locating a title is available only on a disc that contains a title numbers.
- Pressing the CLEAR button resets the Title and Chapter numbers. To clear the Title and Chapter display, press the SEARCH button several times.

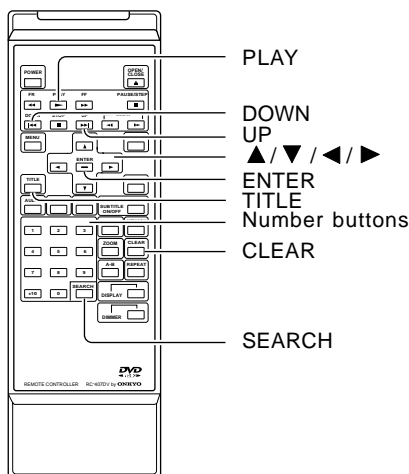

Locating a specific chapter or track directly

Locating a specific chapter or track

1	SEARCH 	<p>Press SEARCH.</p> <p>Skip steps 1 and 2 if you are using an VIDEO CD/audio CD. e.g. DVD video</p> <p>Title: 1 Chapter: 1</p>
2		<p>Press ▼ to highlight the space next to Chapter.</p> <p>e.g. DVD video</p> <p>Title: 1 Chapter: 1</p>
3		<p>Press the corresponding number buttons of the chapter or track you want.</p> <p>You can use the +10 button to select numbers from 10 through 99. e.g. To select chapter or track 25 (VIDEO/Audio CD)</p> <ul style="list-style-type: none"> • 2 → 5 • +10 → +10 → 5 <p>Title: 1 Chapter: 25 Track: 25</p>
4	PLAY 	<p>Press PLAY.</p> <p>Playback starts from chapter 1 of the selected title.</p>

DOWN 	<p>Press Down ◀◀ or Up ▶▶ repeatedly to display the chapter or track number you want.</p> <p>The DVD player starts playback from the selected chapter or track.</p> <p>◀◀ : To locate preceding chapters or tracks When you press the DOWN ◀◀ button, the DVD player starts playback from the beginning of the current chapter or track. When you press the DOWN ◀◀ button twice, the DVD player starts playback from the beginning of the preceding chapter or track.</p> <p>▶▶ : To locate succeeding chapters or tracks</p>
UP 	

Notes:

- Some titles may not display chapter numbers.
- When you set "Title Stop" to "Off" [39], you can access chapters in another title. If you go back to the preceding title by pressing the DOWN ◀◀ button, the DVD player locates the first chapter of the title. When "Title Stop" is set to "On", you can access chapters only within the current title.

■ To select a title and chapter number at the same time

Press the ▲/▼ buttons to highlight the space next to "Title", and enter the title number using the number buttons.

Note:

Pressing the CLEAR button resets the Title and Chapter numbers. To clear the Title, Chapter display, press the SEARCH button several times.



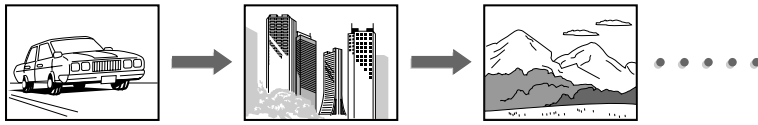

Playing From the Desired Location

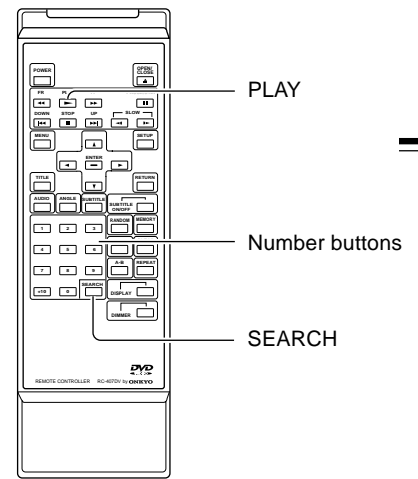

You can locate a specific location by entering its corresponding time (hours, minutes, seconds).

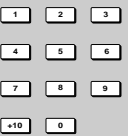
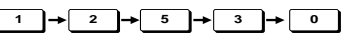
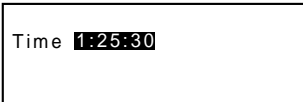

Entering the time of the desired location

- 1** **SEARCH**

Press SEARCH twice.
You may have to press further depending on the disc. Press the button repeatedly until the following indication appears.

- 2** **Number buttons**

Press the number buttons to enter the time.
e.g. 

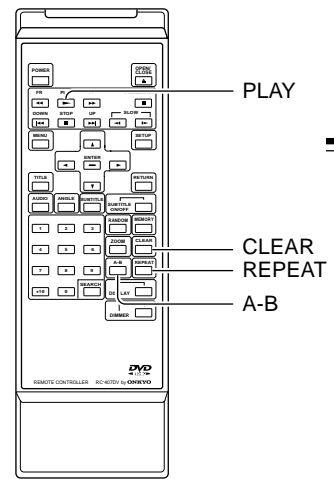
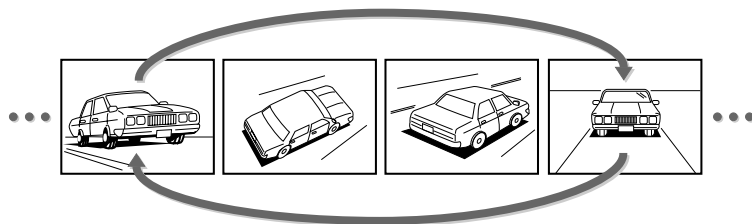
- 3** **PLAY**

Press PLAY.
Playback starts from the desired location.

Notes:

- Some discs may not respond to this process.
- Some scenes may not be located precisely as you specified.
- This method for accessing specific locations is available only within the current title of the DVD video or within the current track of the VIDEO CD/audio CD.

Playing Repeatedly



You can play back a specific title, chapter, track, or segment repeatedly.
(Title repeat, chapter/track repeat, A-B repeat)

Repeating a title, chapter, or track

DVD VCD CD

Repeating a specific segment

DVD VCD CD

- 1 Select the title, chapter, or track you want to repeat.
[20], [21]
- 2 **REPEAT**
[REPEAT] Press **REPEAT**.
Each time you press the REPEAT button, the repeat mode changes as follows.
 - **DVD video**
 - Chapter Repeat Repeats the same chapter.
 - Title Repeat Repeats the same title.
 - Repeat Off Resumes normal playback.
 - **VIDEO CD / Audio CD**
 - Track Repeat Repeats the same track.
 - All Repeat Repeats the entire disc.
 - Repeat Off Resumes normal playback.

- 1 **A-B**
[A-B] Press **A-B** at the beginning of the segment (point A) you want to play repeatedly.
- 2 **A-B**
[A-B] Press **A-B** again at the end of the segment (point B).
The DVD player automatically returns to point A and starts repeat playback of the selected segment (A-B).

To resume normal playback

CLEAR
[CLEAR] Press **CLEAR**.

To resume normal playback

CLEAR
[CLEAR] Press **CLEAR**.

Note:

Some discs may not permit repeat operation.

Notes:

- Some discs may not permit A-B repeat operation.
- You can specify a segment only within the current title or track.
- You cannot set the A-B repeat function for segment that include multiple camera angles.
- There may be a slight difference between point A and the location where playback actually resumes depending on the disc.

Playing in a Favorite Order

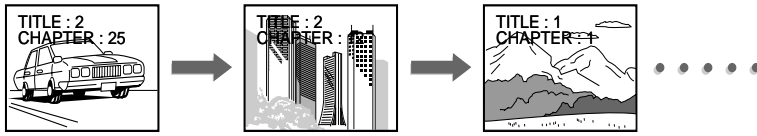

You can combine your favorite titles, chapters, or tracks and play them in any order. You can program up to 28 selections into the memory. (Memory playback)

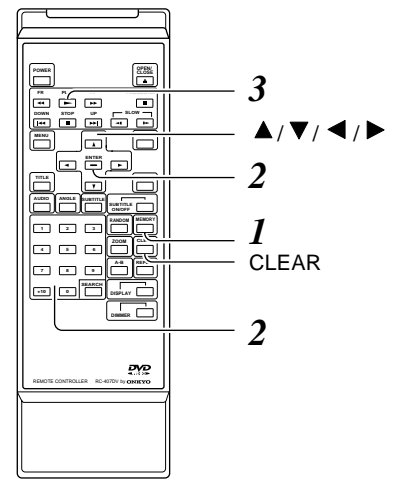

DVD VCD CD

Setting titles, chapters, or tracks in a favorite order

1 **MEMORY**

Insert a disc and press **MEMORY** during stop.

The following display appears.

MEMORY			
T	C	T	C
1	--	8	--
2	--	9	--
3	--	10	--
4	--	11	--
5	--	12	--
6	--	13	--
7	--	14	--
15	--	16	--
17	--	18	--
19	--	20	--
21	--	22	--
23	--	24	--
25	--	26	--
27	--	28	--

T: Title number
C: Chapter number

2

Select the items in the order you want by pressing the number buttons, then **ENTER** for each item.

Each time you press the **◀/▶** button, the -- indication next to T and C is highlighted in turn. Highlight where you want to enter, then press the number buttons.

e.g. To play chapter 25 in title 2, chapter 12 in title 2, all the chapters in title 1, and chapter 2 in title 4.

Memory 1: **◀** → 2 → **▶** → 2 → 5 → **ENTER**

Memory 2: 1 → 2 → **ENTER**

Memory 3: **◀** → 1 → **ENTER**

Memory 4: **◀** → 4 → **▶** → 2 → **ENTER**

To select tracks from a VIDEO CD/audio CD in order, press the **number buttons** for the track, then press the **ENTER** button for each selection you want.

MEMORY											
T	C	T	C	T	C	T	C	T	C	T	C
1	02	02	8	--	--	15	--	--	22	--	--
2	02	12	9	--	--	16	--	--	23	--	--
3	01	--	10	--	--	17	--	--	24	--	--
4	04	02	11	--	--	18	--	--	25	--	--
5	--	--	12	--	--	19	--	--	26	--	--
6	--	--	13	--	--	20	--	--	27	--	--
7	--	--	14	--	--	21	--	--	28	--	--

To select another chapter in the same title, you do not need to select the title number.

3 **PLAY**

Press **PLAY** while the **MEMORY** display appears on the TV screen.

The DVD player starts memory playback.

■ To change the programmed selections

- While the MEMORY display appears on the TV screen, press **▲/▼** to move the highlighted bar to the item you want to change.
- Change the selection following the instructions in step 2.

■ To cancel the programmed selections

- While the MEMORY display appears on the TV screen, press **▲/▼** to move the highlighted bar to the item you want to cancel.
- Press **CLEAR**.

■ To resume normal playback from memory playback

CLEAR Press **CLEAR**.
The MEMORY indicator disappears.

■ To program during playback

If you press the **MEMORY** button during playback, a display appears to accept your programming. If you further press the **DISPLAY** button, you can display the MEMORY display also. Follow steps 2 and 3.

Notes:

- Some discs may not permit memory playback operation.
- If you press the **REPEAT** button during memory playback, the DVD player repeats the current memory playback.
- You cannot select title, chapter, and track numbers not included on the disc.
- If you press the **MEMORY** or **RETURN** button while the MEMORY display appears on the TV screen, the MEMORY display disappears.
- The programmed selections will be cleared when you turn off the DVD player.

Playing in Random Order



You can play back titles, chapters within a title, or tracks in random order. (Random playback)

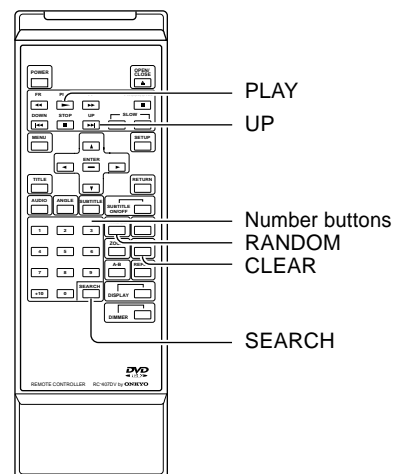

DVD

Playing titles in random order

DVD VCD CD

Playing chapters or tracks in random order

1 **RANDOM** **Press RANDOM twice during stop.**



Title Random

If you press the RANDOM button during playback, the DVD player automatically starts random playback after finishing the current title.

2 **PLAY** **Press PLAY.**



The DVD player starts random playback. Press the PLAY button within about 5 seconds after you press the RANDOM button.

1



Press the appropriate number buttons for the title which contains the chapters you want to play in random order.

Skip this step if you are using VIDEO CD/ audio CD.

e.g. To play the chapters in title 2 in random order (DVD video disc)

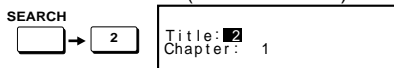

2 **RANDOM** **Press RANDOM during stop.**



(DVD video)	(VIDEO CD/audio CD)
Chapter Random	Track Random
Title: 2	Track: 1
Chapter: 1	

If you press the RANDOM button during playback, the DVD player automatically starts random playback after finishing the current chapter or track.

3 **PLAY** **Press PLAY.**



The DVD player starts random playback. Press the PLAY button within about 5 seconds after you press the RANDOM button

To resume normal playback



To resume normal playback



Notes:

- Some discs may not permit random playback operation.
- You cannot use the random playback function in conjunction with the memory playback function.

Notes:

- Some discs may not permit random playback operation.
- You cannot use the random playback function in conjunction with the memory playback function.
- If you press the UP **▶▶** button during random playback, the DVD player goes to another chapter or track and starts random playback.

Zooming a Picture

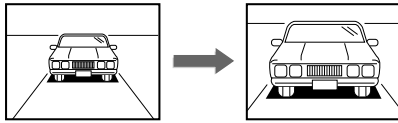

You can magnify areas within a picture.

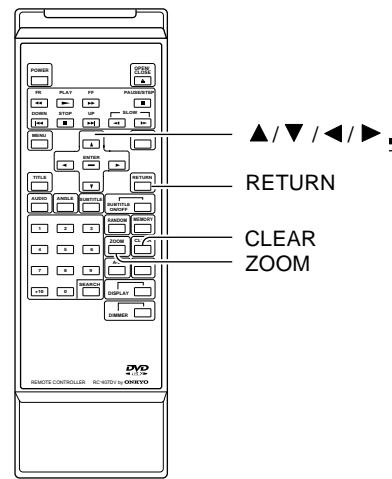

Zooming a picture

DVD

ZOOM



Press **ZOOM** during normal, slow or still playback.

If you further press the **ZOOM** button repeatedly, the magnification level increases.

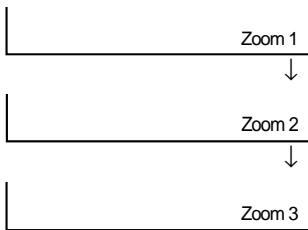

RETURN

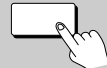

To reduce the magnification level, press the **RETURN** button.

If you press the **▲/▼/◀/▶** buttons, the zoom point shifts. When the zoom point reaches an edge of the picture, the color of "Zoom" changes.

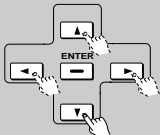

CLEAR



Pressing the **CLEAR** button restores the zoom point to the center of the picture.

■ To resume normal playback

ZOOM

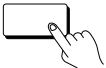

Press **ZOOM** repeatedly so that "Zoom" disappears.

Notes:

- Some discs may not respond to zoom feature.
- During some scenes, the buttons may not work as described above.
- Zooming does not work on subtitles or menus included on DVD videos.
- During zoom playback, the **▲/▼/◀/▶** buttons cannot work on menus included on the DVD video. If you want to view the menus, cancel the zoom playback.
- The magnification level varies depending on the picture size you select. [35](#)

Selecting the Camera Angle

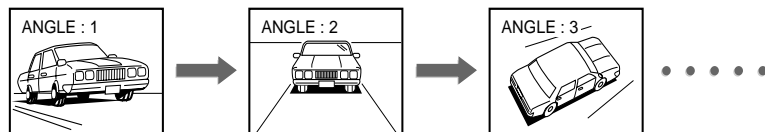

If the scene was recorded from multiple angles, you can easily change the camera angle of the scene you are watching.

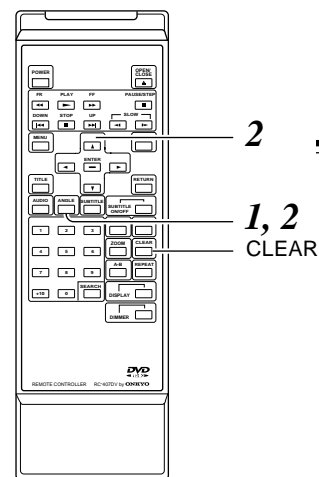

Changing the camera angle

DVD

1

Press ANGLE while playing a scene recorded with multiple angles.

While playing a scene recorded with multiple angles, the angle icon (📹) appears in the DVD display and on the TV screen. Press the ANGLE button while the angle icon is displayed.

■ To turn off the angle number display

CLEAR

Press CLEAR.

■ To disable the angle icon display on the TV

From the on-screen displays, set "On-Screen Displays" to "Off". [32] [37]
Monitor the DVD display when you want to change the camera angle.

2

Press ANGLE or ▲ while the angle number is displayed on the TV screen.

Each time you press the ANGLE or ▲ button, the camera angle changes.

▼ : Cycles backwards

You can change the camera angle directly by pressing the number buttons corresponding to its angle number instead of using the ▲/▼ buttons.

Notes:

- You can change the camera angle during still playback. The camera angle changes to the new setting when you resume normal playback.
- If you pause a picture immediately after changing the camera angle, the resumed playback picture may not display the new camera angle.

Selecting a Language

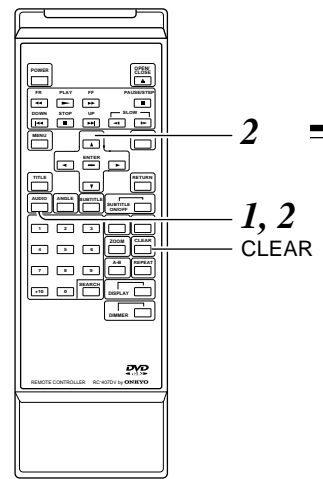
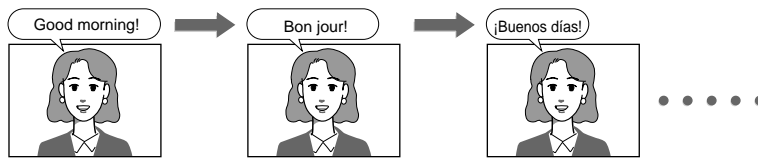

You can select a preferred language and sound recording system from those included on the DVD video.

Selecting a playback audio setting

1 Press **AUDIO** during playback.

The current audio setting is displayed for about 3 seconds.

Language
Recording system
Audio channel

Position number

Audio 1 ENG PCM 2CH
Audio Out Select: Bitstream
Output sound format

The abbreviation of the language appears instead of the language name. Refer to the list of languages and their abbreviations. [40](#)

2 Press **AUDIO** or **▲** while the audio setting is displayed on the TV screen.

Each time you press the **AUDIO** or **▲** button, the audio settings included on the DVD video change.

e.g.

Audio 1 ENG PCM 2CH

↓

Audio 2 FRE □□ 6CH

↓

Audio 3 SPA PCM 2CH

⋮

▼ : Cycles backwards

About recording systems

This DVD player uses the Dolby Digital, DTS, MPEG2, and PCM recording systems and cannot play DVD videos recorded in any other recording system.

Dolby Digital 5.1 Channel may be displayed as "□□ 6CH."

Selecting sound channels of VIDEO CDs

A VIDEO CD may have left and right sound channels and contain sounds or languages on each. You can switch these two channels to hear a preferred sound or language.

During playback, press **AUDIO** repeatedly to select the sound channel.

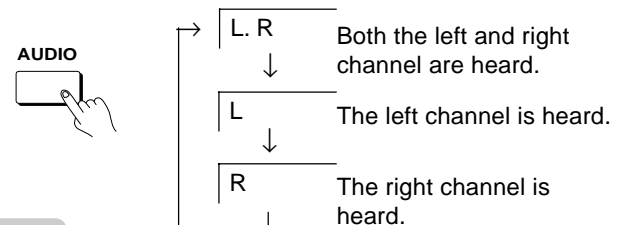

Notes:

- Some discs allow you to change audio selections only via the disc menu. If this is the case, press the **MENU** button and choose the appropriate language from the selections on the disc menu.
 - When you turn on the DVD player or replace a disc, DVD player returns to the initial default setting. [33](#)
- When you select a sound track which is not included on the disc, the DVD player plays a prior sound track programmed on the disc.

To turn off the audio setting display



Output sound conversion table (sampling frequency/quantization bit)

Discs	Recording system	Audio selection from the menu 32 36 and output jacks on the rear panel						
		"Bitstream"		"Analog 2ch"		"PCM"		
		DIGITAL OUTPUT jack	ANALOG OUT jacks	DIGITAL OUTPUT jack	ANALOG OUT jacks	DIGITAL OUTPUT jack	ANALOG OUT jacks	
DVD video discs	Dolby Digital	Bitstream	48 kHz/20 bit	Bitstream	48 kHz/20 bit	48 kHz/16 bit	48 kHz/20 bit	
		48 kHz/16 bit	48 kHz/16 bit	48 kHz/16 bit	48 kHz/16 bit	48 kHz/16 bit	48 kHz/16 bit	
		48 kHz/20 bit	48 kHz/16 bit	48 kHz/20 bit	48 kHz/16 bit	48 kHz/16 bit	48 kHz/20 bit	
		48 kHz/24 bit	48 kHz/16 bit	48 kHz/20 bit	—	48 kHz/24 bit	48 kHz/16 bit	48 kHz/20 bit
		96 kHz/16 bit	48 kHz/16 bit	48 kHz/16 bit	—	96 kHz/16 bit	48 kHz/16 bit	48 kHz/16 bit
		96 kHz/20bit	48 kHz/16 bit	48 kHz/20 bit	—	96 kHz/20 bit	48 kHz/16 bit	48 kHz/20 bit
	96 kHz/24 bit	48 kHz/16 bit	48 kHz/20 bit	—	96 kHz/24 bit	48 kHz/16 bit	48 kHz/20 bit	
Audio CDs	DTS	Bitstream	—	Bitstream	—	—	—	
	MPEG2	Bitstream (7.1ch)	—	Bitstream (2ch)	44.1 kHz/16 bit	44.1 kHz/16 bit	44.1 kHz/16 bit	
	Linear PCM 44.1 kHz/16 bit	44.1 kHz/16 bit	44.1 kHz/16 bit	44.1 kHz/16 bit	44.1 kHz/16 bit	44.1 kHz/16 bit	44.1 kHz/16 bit	
	DTS	Bitstream	(Noise)	Bitstream	(Noise)	Bitstream	(Noise)	

Selecting Subtitles

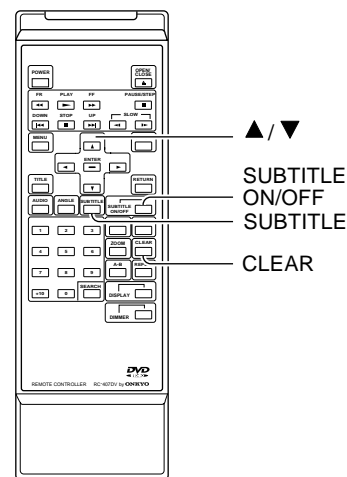

You can display subtitles on the TV screen and select a subtitle language from those included on the DVD video.

Selecting a subtitle language DVD

To Turn subtitles on or off DVD

1

PRESS SUBTITLE during playback.
The current subtitle setting is displayed for about 3 seconds.

Subtitle: 1 ENG On
 |
 Language
 Position number

The abbreviation of the language appears instead of the language name. Refer to the list of languages and their abbreviations. [40](#)

2

PRESS SUBTITLE or ▲ while the subtitle setting is displayed on the TV screen.

Each time you press the SUBTITLE or ▲ button, the subtitle languages included on the DVD video change.

e.g.

Subtitle: 1 ENG On
 ↓
Subtitle: 2 FRE On
 ↓
Subtitle: 3 SPA On
 ⋮

▼ : Cycles backwards

PRESS SUBTITLE ON/OFF during playback.

Subtitle: 1 ENG On

Good morning!

Appears for about 3 seconds

Subtitles

To turn off the subtitles

PRESS SUBTITLE ON/OFF.
The subtitles disappear.

Subtitle: 1 ENG Off

Appears for about 3 seconds

To turn off the subtitle setting display

PRESS CLEAR.

CLEAR

- Notes:**
- When you turn on the DVD player or replace a disc, DVD player returns to the initial default setting. [34](#)
 - When you select a subtitle language which is not included on the disc, the DVD player plays a prior language programmed on the disc.
 - During some scenes, the subtitles may not appear immediately after you change the subtitle language by pressing the ▲/▼ buttons.

- Notes:**
- Some DVD videos are set to display subtitles automatically, and you cannot turn them off even if you set the subtitle function to off.
 - During some scenes, the subtitles may not appear immediately after you select "On."
 - Some DVD videos will allow you to make subtitle selections and turn subtitles on or off only via the disc menu.

Advanced Playback

Viewing the Operational Information

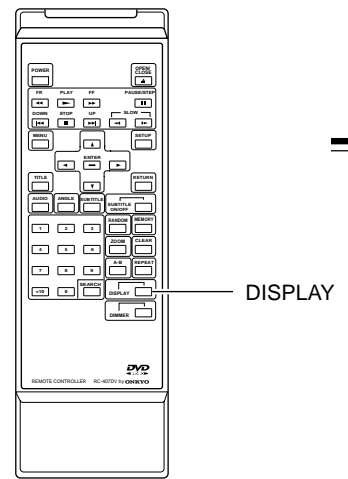

You can view information about a disc and its operational status on the TV screen.

Checking the operational status DVD VCD CD

Checking the remaining time and setting status DVD VCD CD

Press DISPLAY during stop.
Each time you press the DISPLAY button, the on-screen display changes as follows.

DVD video

e.g.

Title: 2	Chapter: 1	Stop	Operational status
----------	------------	------	--------------------

Turns off.

VIDEO CD/Audio CD

e.g.

Track: 1	Total 0:46:30	Stop	Operational status
----------	---------------	------	--------------------

Turns off.

Total playing time of the disc

Press DISPLAY during playback.
Each time you press the DISPLAY button, the on-screen display changes as follows.

DVD video

e.g.

Playback mode	Current title number	Current chapter number	Operational status
Title: 3	Chapter: 2	Chapter Repeat	Elapsed time and remaining time of the current title
Audio: 1 ENG	Subtitle: 12 ENG	Angle: 1	Elapsed time and remaining time of the current chapter
			Current audio setting
			Current subtitle setting
			Current angle setting

The abbreviation of the language (e.g. ENG) appears instead of the language name. Refer to the list of languages and their abbreviations. **40**

↓

Bit Rate: 0	10	6.0 Mbps
-------------	----	----------

Data transfer rate (Mbit/s)
= Amount of picture, sound and subtitle data in the DVD video transferred per second.
The larger the value is, the more data processed, but this does not necessarily insure better picture quality.

↓

Turns off.

VIDEO CD/Audio CD

e.g.

Playback mode	Current track number	Operational status
Track: 3	Disc	Track Repeat
		Elapsed time and remaining time of the current track
		Elapsed time and remaining time of the disc

↓

Turns off.

Customizing the Function Settings

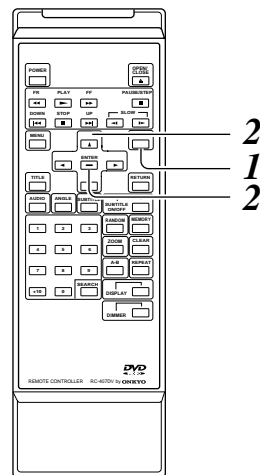

You can change the default settings to customize performance to your preference.

Setting procedure

1 Press **SETUP** during stop.
The following on-screen display appears.

2 Press **◀/▶** to select a symbol for the setting you want to change (See the next page.)

- Setting on languages
- Settings on playback picture conditions
- Setting on sound output
- Setting on displays
- Setting on operational options

3 Press **▲/▼** to select the setting you want to change, then press **ENTER**.

4 Change the selection by **▲/▼** or other buttons, referring to the pages from 37, then press **ENTER**.

5 Repeating steps 3 and 4 to change other settings.
To select another symbol, go back to step 2.

6 Press **SETUP**
The on-screen displays disappears.

■ To return to the previous display press **RETURN**







Notes:

- The on-screen display disappears when you press the **SETUP** button.
- The **SETUP** button can function even during normal playback, however some operations may be inaccessible, and a message will appear. In this case, try again after playing is stopped.

Customizing the Function Settings (continued)

Setting details

	Setting	Details	Page
	On-screen language	<small>DVD</small> <small>VCD</small> <small>CD</small> To select a preferred language for on-screen displays.	33
	Disc menu language	<small>DVD</small> To select a preferred language for disc menus.	33
	Audio language	<small>DVD</small> To select a preferred language for the sound track.	33
	Subtitle language	<small>DVD</small> To select preferred language for subtitles.	34
	TV shape	<small>DVD</small> To select a picture size according to the aspect ratio of your TV.	35
	Black level	<small>DVD</small> <small>VCD</small> To select the black level of playback pictures.	35
	PAL/AUTO	<small>DVD</small> <small>VCD</small> To select to the video system of a disk	35
	Audio out select	<small>DVD</small> <small>VCD</small> <small>CD</small> To select an output sound format corresponding to your system connection.	36
	Dynamic range control	<small>DVD</small> To turn on or off a function that makes faint sound easier to hear even if you lower the volume during late hours playback.	36
	Karaoke vocal	<small>DVD</small> To turn on or off the vocal output during KARAOKE disc playback.	36
	Extended audio features	<small>DVD</small> To turn on or off special language for visually impaired persons.	36
	On-screen displays	<small>DVD</small> <small>VCD</small> <small>CD</small> To turn on or off the operational status display (On-screen display) on the TV screen.	37
	OSD background color	<small>DVD</small> <small>VCD</small> <small>CD</small> To select the background color for on-screen displays.	37
	Extended subtitle features	<small>DVD</small> To turn on or off special subtitles for hearing impaired persons.	37
	Screen saver	<small>DVD</small> To turn on or off the screen saver.	37
	Pause/Still	<small>DVD</small> To select the resolution of still pictures.(Field/Frame)	38
	Parental lock	<small>DVD</small> To turn on or off the parental lock function.	38
	Title Stop	<small>DVD</small> To turn on or off a feature that automatically stops playback after a title has been viewed.	38
	PBC	<small>VCD</small> To use the menu screen when playing a PBC-controllable VIDEO CD.	38

(Continued)

Setting details

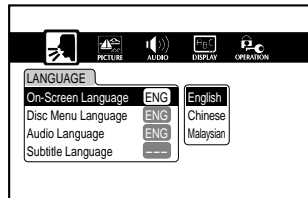

On-screen language



English : To view on-screen displays in English.
 Chinese : To view on-screen displays in Chinese.
 Malaysian : To view on-screen displays in Malaysian.

Disc menu language



English : To display disc menus in English.
 Chinese : To display disc menus in Chinese.
 Malaysian : To display disc menus in Malaysian.
 Others : To make a further choice.
 After pressing the ENTER button, follow steps 1) - 4) below.

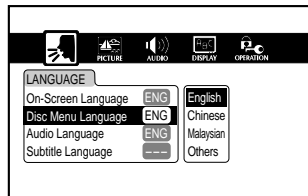

- 1) Obtain the abbreviation of the preferred language from the list **40**.
- 2) Select the first character by pressing the **▲/▼** buttons.
- 3) Press the **◀/▶** buttons to shift and select the second character by pressing the **▲/▼** buttons.
- 4) Press the ENTER button.

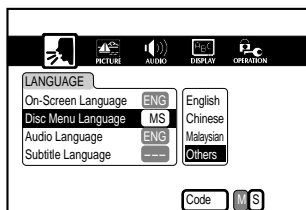

Notes:

- Some DVD video may not include your pre-selected language. In this case, the DVD player automatically displays disc menus consistent with the disc's initial language setting.

Audio language

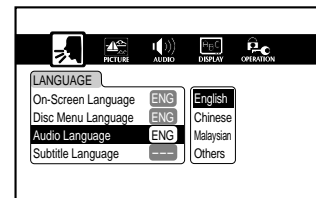

English : To play sound tracks in English.
 Chinese : To play sound tracks in Chinese.
 Malaysian : To play sound tracks in Malaysian.
 Others : To make a further choice.
 After pressing the ENTER button, follow steps 1) - 4) below.

- 1) Obtain the abbreviation of the preferred language from the list **40**.
- 2) Select the first character by pressing the **▲/▼** buttons.
- 3) Press the **◀/▶** buttons to shift and select the second character by pressing the **▲/▼** buttons.
- 4) Press the ENTER button.

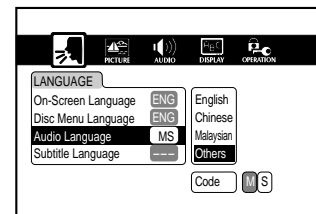

Notes:

- Some DVD videos may be played in a different language than you selected. A prior language may be programmed on the disc.

(Continued)

Customizing the Function Settings (continued)

Setting details

Subtitle language

DVD

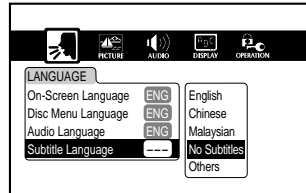

English : To display subtitles in English.
Chinese : To display subtitles in Chinese.
Malaysian : To display subtitles in Malaysian.
Others : To make a further choice.
After pressing the ENTER button,
follow steps 1) - 4) below.

- 1) Obtain the abbreviation of the preferred language from the list **40**.
- 2) Select the first character by pressing the ▲/▼ buttons.
- 3) Press the ◀/▶ buttons to shift and select the second character by pressing the ▲/▼ buttons.
- 4) Press the ENTER button.

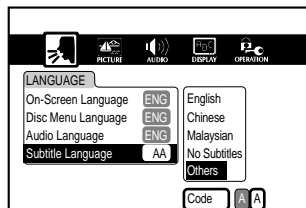

Notes:

- Some DVD videos may be set to display subtitles in a different language than you selected. A prior subtitle language may be programmed on the disc.
- Some DVD videos allow you to change subtitle selections only via the disc menu. If this is the case, press the MENU button and choose the appropriate subtitle language from the selection on the disc menu.

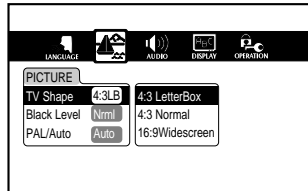

TV Shape



4:3 LetterBox:

Select when a 4:3 TV is connected. Displays theatrical images with masking bars above and below the picture.



4:3 Normal:

Select when a 4:3 TV is connected. Displays pictures cropped to fill your TV screen. Either or both sides of the picture are cut off.



16:9 Widescreen: Select when a 16:9 wide TV is connected.

Notes:

- The displayable picture size is preset on the DVD video. Therefore, the playback picture of some DVD videos may not conform to the picture size you select.
- When you play DVD videos recorded in the 4:3 picture size only, the playback picture always appears in the 4:3 picture size regardless of the TV shape setting.
- If you select "16:9 Widescreen" and you own a 4:3 TV set, the DVD playback picture will be horizontally distorted during playback. Images will appear to be horizontally compressed. Always be sure that your TV shape conforms to the actual TV in use.

Black level

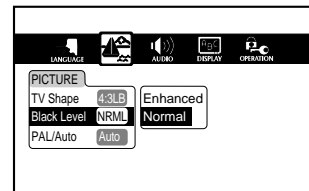

Set to your preference and monitor's ability. Select the brightness of playback pictures.

Enhanced: Expanded black level. (0 IRE)
Normal: Standard black level. (7.5 IRE)

PAL/Auto

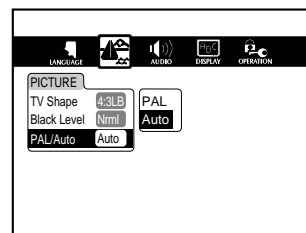

PAL: for PAL disc. Connect a PAL TV.
Auto: NTSC disc and PAL disc are automatically identified.
Connect a multi-TV (applicable to NTSC, PAL)
A picture may be disturbed when the NTSC or PAL signal recorded is switched.

Customizing the Function Settings (continued)

Setting details

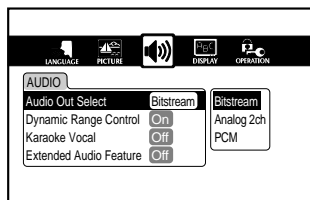

Audio Out Select

DVD VCD CD

Select the output sound format corresponding to your system connection.

For details of sound recording systems, see 28.

Bitstream: Select when connected to an amplifier equipped with a Dolby Digital, DTS, MPEG1 or MPEG2 decoder. 14 15
The DVD player outputs digital audio information in the bitstream format when you play a DVD video recorded on the Dolby Digital, DTS, MPEG1 or MPEG2 recording system.

Analog 2ch: Select when connected to a TV, or Dolyby Pro Logic or stereo system via the analog audio jacks. 12 14

PCM: Select when connected to a 2 channel digital stereo amplifier. 15
The DVD player outputs sounds in the PCM 2ch format when you play a DVD video recorded on the Dolby Digital, MPEG1 or MPEG2 recording system.

Dynamic range control

DVD

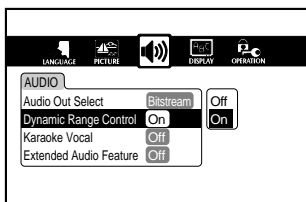

On: Dynamic range is reduced.
Off: Full dynamic range is maintained.

Notes:

- This function works only on playback of Dolby Digital recorded discs.
- The level of Dynamic Range Reduction may differ depending on the DVD video.

Karaoke vocal

DVD

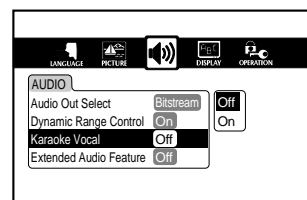

On: The primary vocal is output when it is recorded on the disc.

Off: The primary vocal is not output.

Notes:

The vocal output feature is used during playback of Dolby Digital (multi-channel) recorded DVD KARAOKE discs. This feature allows you to turn off vocal audio tracks, or restore them for background accompaniment.

When playing KARAOKE, connect appropriate audio equipment as an amplifier to the DVD player.

Extended audio features

DVD

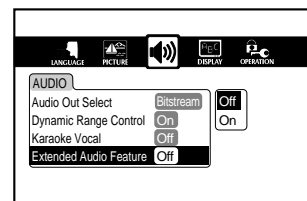

Some DVD videos contain special language track that describes the actions on-screen for visually impaired persons. The DVD player automatically plays this special feature.

On: This function works.

Off: This function does not work.

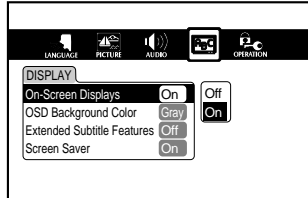
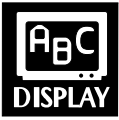

ON-Screen Display



Off: Operational modes (e.g. "PLAY", ) are not displayed.

On: Operational modes (e.g. "PLAY", ) are displayed on-screen.

OSD Background Color

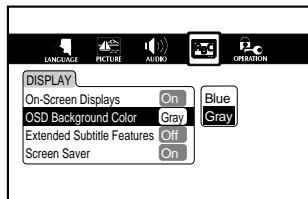

Blue: Blue background.

Gray: Gray background.

Extended Subtitle Features

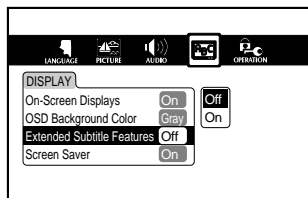

Some DVD videos contain special subtitles, an enhancement of closed captioning for hearing impaired persons. The DVD player automatically displays these special subtitles.

Off: This function does not work.

On: This function works.

Screen Saver

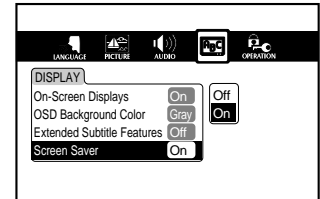

Off: The screen saver does not work.

On: The screen saver works.

Customizing the Function Settings (continued)

Setting details

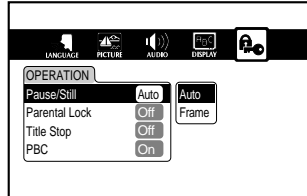

After you select **OPERATION** [32], adjust to your preference.

Pause / Still



Auto: For normal use. Image can be paused without shaking.

Frame: The resolution of still pictures is improved, so that you can make a motionless picture more clearer when you pause it.

Parental Lock



Parental Lock

DVD videos equipped with the parental lock function are rated according to their content. The contents allowed by a parental lock level and the way a DVD video can be controlled may vary from disc to disc. For example, if the disc allowed you could edit out violent scenes unsuitable for children and replace them with more suitable scenes, or lock out playback of the disc altogether.

- DVD videos may or may not respond to the parental lock settings. This is not a defect in the DVD player. Make sure this function works with your DVD videos.

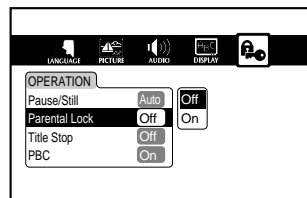

- On:** To activate the parental lock feature or change the settings. After pressing the ENTER button, follow steps 1) - 3) below.
- Off:** The parental lock feature does not function. After pressing the ENTER button, follow steps.

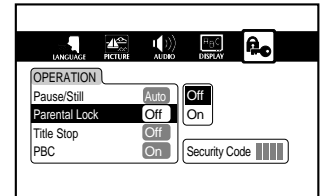

- Press the number buttons to create a personal 4-digit security code, then press ENTER.

If you make a mistake before pressing the ENTER button, press the CLEAR button and enter your 4-digit security code again.

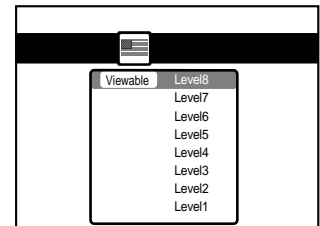

- Press the ◀/▶ buttons to select the country whose standards were used to rate the DVD video, then press the ENTER button.

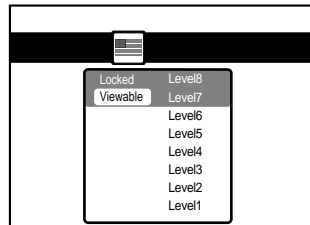

- 3) Press the ▲/▼ buttons to select the parental lock level, then press the ENTER button.

You cannot play DVD videos rated higher than the level you selected unless you cancel the parental lock function. For example, when you select level 7, discs rated higher than level 7 are locked out and cannot be played.

The parental lock level is equivalent to the following USA movie ratings.

LEVEL 7: NC-17 LEVEL 3: PG
 LEVEL 6: R LEVEL 1: G
 LEVEL 4: PG 13

- **To change the parental lock level:**
 Follow steps 1) - 3).

- **To change your 4-digit security code:**
 (1) After selecting "On" or "Off" [38], press the STOP button for times, then press the ENTER button. STOP STOP ENTER

The 4-digit security code is cleared.

- (2) Press the number buttons to create a new 4-digit security code.
- (3) Press the ENTER button.

Title Stop

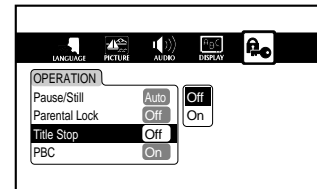

- On:** The DVD player stops after playback of a title is completed.
- Off:** The DVD player continues after playback of a title is completed.

PBC

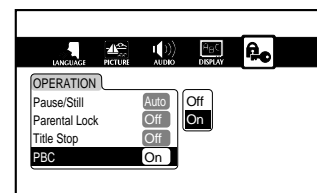

- On:** To view the menu screen when playing a PBC-featuring VIDEO CD.
- Off:** For playing without using the menu screen.

* PBC is the abbreviation of Playback Control.

Table of Languages

Table of languages and their abbreviations

Abbreviation of the Language	Language	Abbreviation of the Language	Language	Abbreviation of the Language	Language	Abbreviation of the Language	Language
—	No alternate language	EO	Esperanto	LN	Lingala	SL	Slovenian
CHI (ZH)	Chinese	ET	Estonian	LO	Laotian	SM	Samoan
DUT (NL)	Dutch	EU	Basque	LT	Lithuanian	SN	Shona
ENG (EN)	English	FA	Persian	LV	Latvian, Lettish	SO	Somali
FRE (FR)	French	FI	Finnish	MG	Malagasy	SQ	Albanian
GER (DE)	German	FJ	Fiji	MI	Maori	SR	Serbian
ITA (IT)	Italian	FO	Faroese	MK	Macedonian	SS	Siswati
JPN (JA)	Japanese	FY	Frisian	ML	Malayalam	ST	Sesotho
KOR (KO)	Korean	GA	Irish	MN	Mongolian	SU	Sundanese
MAY (MS)	Malay	GD	Scottish Gaelic	MO	Moldavian	SV	Swedish
SPA (ES)	Spanish	GL	Galician	MR	Marathi	SW	Swahili
AA	Afar	GN	Guarani	MT	Maltese	TA	Tamil
AB	Abkhazian	GU	Gujarati	MY	Burmese	TE	Burmese
AF	Afrikaans	HA	Hausa	NA	Nauru	TG	Tajik
AM	Amharic	HI	Hindi	NE	Nepali	TH	Thai
AR	Arabic	HR	Croatian	NO	Norwegian	TI	Tigrinya
AS	Assamese	HU	Hungarian	OC	Occitan	TK	Turkmen
AY	Aymara	HY	Armenian	OM	(Afan) Oromo	TL	Tagalog
AZ	Azerbaijani	IA	Interlingua	OR	Oriya	TN	Setswana
BA	Bashkir	IE	Interlingue	PA	Panjabi	TO	Tongan
BE	Belorussian	IK	Inupiak	PL	Polish	TR	Turkish
BG	Bulgarian	IN	Indonesian	PS	Pashto, Pushto	TS	Tsonga
BH	Bihari	IS	Icelandic	PT	Portuguese	TT	Tatar
BI	Bislama	IW	Hebrew	QU	Quechua	TW	Twi
BN	Bengali, Bangla	JI	Yiddish	RM	Rhaeto-Romance	UK	Ukrainian
BO	Tibetan	KA	Javanese	RN	Kirundi	UR	Urdu
BR	Breton	JW	Georgian	RO	Rumanian	UZ	Uzbek
CA	Catalan	KK	Kazakh	RU	Russian	VI	Vietnamese
CO	Corsican	KL	Greenlandic	RW	Kinyarwanda	VO	Volapük
CS	Czech	KM	Cambodian	SA	Sanskrit	WO	Wolof
CY	Welsh	KN	Kannada	SD	Sindhi	XH	Xhosa
DA	Danish	KS	Kashmiri	SG	Sango	YO	Yoruba
DZ	Bhutani	KU	Kurdish	SH	Serbo-Croatian	ZU	Zulu
EL	Greek	KY	Kirghiz	SI	Singhalese		
		LA	Latin	SK	Slovak		

Notes on Discs

This section shows you how to handle, clean, and store discs.

On handling discs

- Do not touch the playback side of the disc.

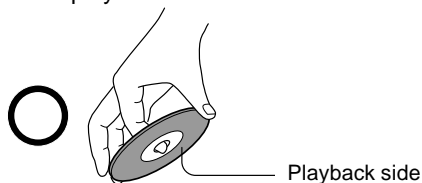

- Do not attach paper or tape to discs.



On cleaning discs

- Fingerprints and dust on the disc cause picture and sound deterioration. Wipe the disc from the center outwards with a soft cloth. Always keep the disc clean.

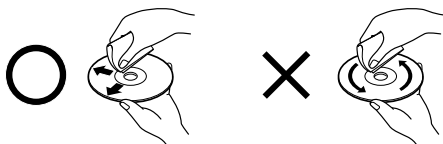

- If you cannot wipe off the dust with a soft cloth, wipe the disc lightly with a slightly moistened soft cloth and finish with a dry cloth.
- Do not use any type of solvent such as thinner, benzene, commercially available cleaners or antistatic spray for vinyl LPs. It may damage the disc.

On storing discs



- Do not store discs in a place subject to direct sunlight or near heat sources.
- Do not store discs in places subject to moisture and dust such as a bathroom or near a humidifier.
- Store discs vertically in a case. Stacking or placing objects on discs outside of their case may cause warping.

About this instruction manual

This instruction manual explains the basic instructions of this DVD player. Some DVD video are produced in a manner that allows specific or limited operation during playback. As such, the DVD player may not respond to all operating commands. Refer to instruction notes of discs.

“⊘” may appear on the TV screen during operation. “⊘” means that the operation is not permitted by the DVD player or the disc.

Notes on Region Numbers

The region number of this DVD player is 3. If region numbers, which stand for their playable area, are printed on your DVD video disc and you do not find  or , disc playback will not be allowed by the player. (In this case, the DVD player displays the message.)

Type of TV system

Connect this DVD player to a TV compatible with PAL/3.58 NTSC systems.

Playable discs

This DVD player can play back the following discs.

	Disc mark	Contents	Disc size	Maximum playback time
DVD video		Audio + Video (moving pictures)	12 cm	Approx. 4 hours (single sided disc) Approx. 8 hours (double sided disc)
			8 cm	Approx. 80 minutes (single sided disc) Approx. 160 minutes (double sided disc)
VIDEO CDs		Audio + Video (moving pictures)	12 cm	Approx. 74 minutes
			8 cm	Approx. 20 minutes
Audio CDs		Audio	12 cm	Approx. 74 minutes
			8 cm (CD single)	Approx. 20 minutes

You cannot play back discs other than those listed above. Do not use discs that are not audio discs (eg. CD-ROMs for use with personal computers), as these could damage the speakers and amplifier.

This DVD player uses the PAL/NTSC color system, and cannot play back DVD video recorded in any other color system (SECAM, etc.).

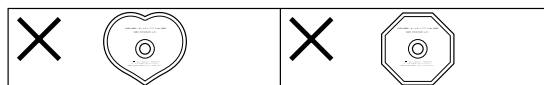

Avoid using heart-shaped or octagonal discs. Playing irregularly shaped discs may damage the internal mechanism of the DVD player.

Do not use discs on which adhesive from adhesive tape or a disc label (if it is a rental disc) remains. Otherwise, you may not be able to eject the discs or the DVD player may become inoperative.

On VIDEO CDs

This DVD player supports the VIDEO CDs equipped with the PBC (Version 2.0) function. (PBC is the abbreviation of Playback Control.) You can enjoy two playback variations depending on types of discs.

- VIDEO CD not equipped with PBC function (Version 1.1)**
Sound and movie can be played on this DVD player in the same way as an audio CD.
- VIDEO CD equipped with PBC function (Version 2.0)**
In addition to operation of the VIDEO CD not equipped with the PBC function, you can enjoy playback with interactive software and with search function by using the menu displayed on the TV screen (Menu Playback). Some of the functions described in this owner's manual may not work with some discs.

Notes on copyright

It is forbidden by law to copy, broadcast, show, broadcast on cable, play in public, and rent copyrighted material without permission.

DVD video are copy protected, and any recordings made from these discs will be distorted.

This product incorporates copyright protection technology that is protected by method claims of certain U.S. patents and other intellectual property rights owned by Macrovision Corporation and other rights owners. Use of this copyright protection technology must be authorized by Macrovision Corporation, and is intended for home and other limited viewing uses only unless otherwise authorized by Macrovision Corporation. Reverse engineering or disassembly is prohibited.

Before Calling Service Personnel

Check the following guide for the possible cause of a problem before contacting service.

Symptoms and correction

Symptom	Cause	Correction	Page
No power.	The power plug is disconnected.	Connect the power plug into the wall outlet securely.	16
No picture.	• The TV is not set to receive DVD signal output.	• Select the appropriate video input mode on the TV so the picture from the DVD player appears on the TV screen.	16
	• The video cable is not connected securely.	• Connect the video cable into the jacks securely.	12-15
No sound.	• The equipment connected with the audio cable is not set to receive DVD signal output.	• Select the correct input mode of the audio receiver so you can listen to the sound from the DVD player.	16
	• The audio cables are not connected securely.	• Connect the audio cable into the jacks securely.	12-15
	• The power of the equipment connected with the audio cable is turned off.	• Turn on the equipment connected with the audio cable.	–
	• The setting of output sound type is not correct.	• Set the audio setting correctly.	28, 36
The playback picture has occasional distortion.	• The disc is dirty.	• Eject the disc and clean it.	41
	• It is in fast forward or fast reverse playback	• Sometimes a small amount of picture distortion may appear. This is not a malfunction.	–
Brightness is unstable or noises are produced on playback pictures.	• The copy protection's effect.	• Connect the DVD player directly to the TV. Avoid connecting the DVD player to a VCR or TV/VCR combination.	12
The DVD player does not start playback.	• No disc is inserted.	• Insert a disc. (Check that the DVD or VIDEO CD/audio CD indicator in the DVD display is lit.)	9
	• An unplayable disc is inserted.	• Insert a playable disc. (Check the disc type and color system.)	41
	• The disc is placed upside down.	• Place the disc with the playback side down.	16
	• The disc is not placed within the guide.	• Place the disc on the disc tray correctly inside the guide.	16
	• The disc is dirty.	• Clean the disc.	41
	• The parental lock function is set.	• Cancel the parental lock function or change the parental lock level.	38
Buttons do not work.	Power supply fluctuations or other abnormalities such as static electricity may interrupt correct operation.	Turn the power on or off with the POWER button. Or disconnect the power plug and insert it into the wall outlet again.	–
The remote controller does not work properly	• The remote controller is not pointed at the remote sensor of the DVD player.	• Point the remote controller at the remote sensor of the DVD player.	11
	• The remote controller is too far from the DVD player.	• Operate the remote controller within about 5 m.	11
	• The batteries in the remote controller are exhausted.	• Replace the batteries with new ones.	11

Because the unit contains a microcomputer to provide advanced functions, it may malfunction due to external noise or static electricity. If this happens, press the POWER switch on the unit and then press it again after about five seconds.

Specifications

DVD player/outputs/supplied accessories

DVD player

Power supply	AC 100-240V, 50/60Hz
Power consumption	22 W
Weight	3.8 kg, 8.4 lbs.
External dimensions	435 × 91 × 306 mm (W/H/D), 17-1/8" × 3-9/16" × 12 1/16" (W/H/D)
Signal system	PAL/3.58 NTSC
Laser	Semiconductor laser, wavelength 650 nm
Frequency range (digital audio)	DVD linear sound : 48 kHz sampling 4 Hz to 22 kHz 96 kHz sampling 4 Hz to 44 kHz Audio CD : 4 Hz to 20 kHz
Signal-to-noise ratio (digital audio)	More than 96 dB (EIAJ)
Audio dynamic range (digital audio)	More than 90 dB (EIAJ)
Harmonic distortion (digital audio)	Less than 0.01 %
Wow and flutter	Below measurable level (less than ±0.001 % (W.PEAK)) (EIAJ)
Operating conditions	Temperature: 5 °C to 35 °C (41 to 95 °F), Operation status: Horizontal

Outputs

Video output	1.0 V (p-p), 75 Ω, negative sync., pin jack × 1
S video output	(Y) 1.0 V (p-p), 75 Ω, negative sync., Mini DIN 4-pin × 1 (C) 0.286 V (p-p), 75 Ω
Color different output	(Y) 1.0 V (p-p), 75 Ω, negative sync., pin jack × 1 (Cb)/(Cr) 0.7 V (p-p), 75 Ω
Audio output (optical audio)	Optical connector × 1
Audio output (digital audio)	0.5 V (p-p), 75 Ω, pin jack × 1
Audio output (analog audio)	2.0 V (rms), 470 Ω, pin jack (L, R) × 1
Headphone terminal	32 Ω (10mW), Impedance; more than 8 Ω

Supplied accessories

S video cable	1
Audio/video connection cable	1
Remote controller (RC-407DV)	1
Batteries (AA)	2
RI cable	1
CV plug	1

- Designs and specifications are subject to change without notice.

ONKYO CORPORATION

Sales & Product Planning Div.: 2-1, Nisshin-cho, Neyagawa-shi, OSAKA 572-8540, JAPAN
Tel: 0720-31-8111 Fax: 0720-33-5222 <http://www.onkyo-intl.com>

ONKYO U.S.A. CORPORATION

18 Park Way, Upper Saddle River, N.J. 07458, U.S.A.
Tel: 201-785-2600 Fax: 201-785-2650 <http://www.onkyousa.com>

ONKYO EUROPE ELECTRONICS GmbH

Liegnitzerstrasse 6, 82194 Grobenzell, GERMANY
Tel: +49-8142-4401-0 Fax: +49-8142-4401-555 <http://www.onkyo.net>

ONKYO CHINA LIMITED

Units 2102-2107, Metroplaza Tower I, 223 Hing Fong Road, Kwai Chung,
N.T., HONG KONG Tel: 852-2429-3118 Fax: 852-2428-9039 <http://www.onkyochina.com>

